

1. Steinschraube.

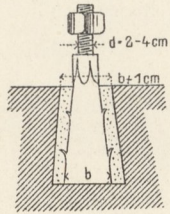

2. Fundamentschraube für Maschinen.

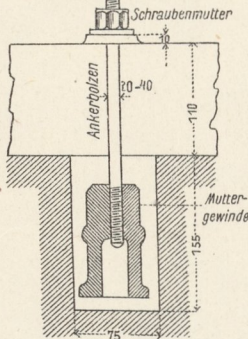

3. Lösbare Verankerung mit Druckplatte.

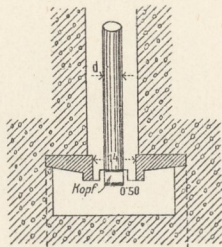

4. Auflager, gleichz. Druckanker.

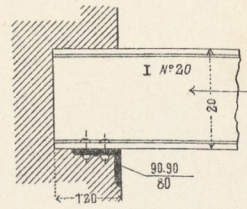

5. Auflager, gleichz. Zuganker.

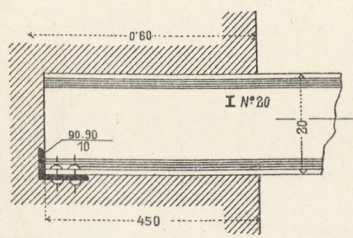

6. Balkonträgerverankerung.

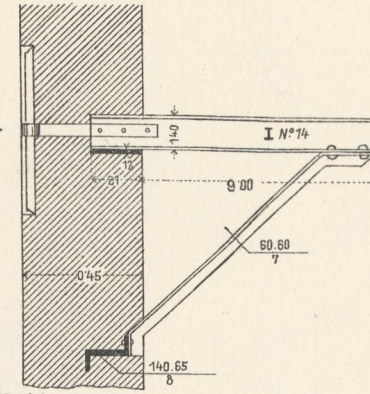

7. Träger-Auflager, gleichz. Druckanker.

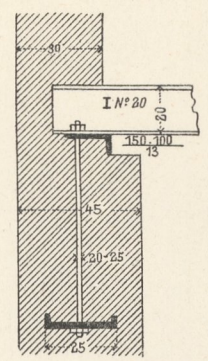

8. Fallender Lagerung. 9. Steigender Lagerung.

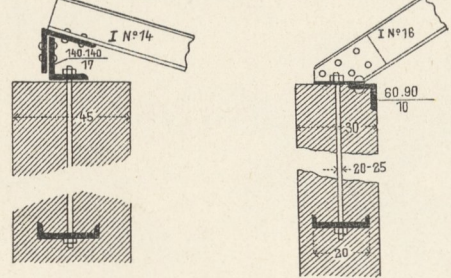

11. Kreuzanker.

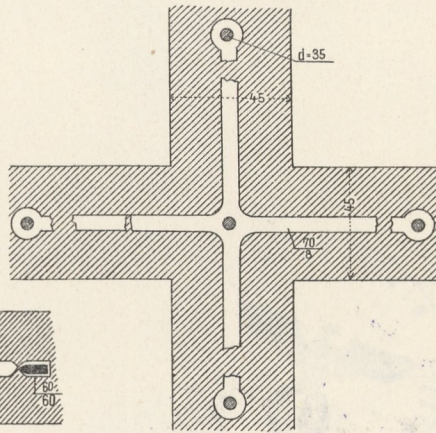

10. Eckanker.

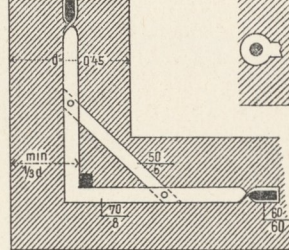

12. Tramschließe seitlich an den Tram befestigt.

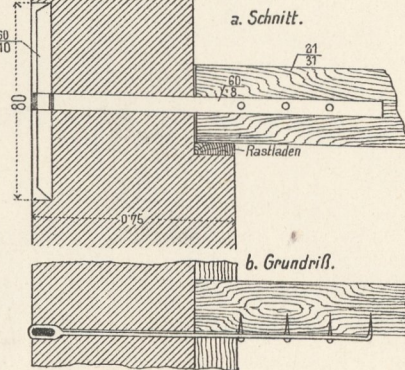

21. Eckanker.

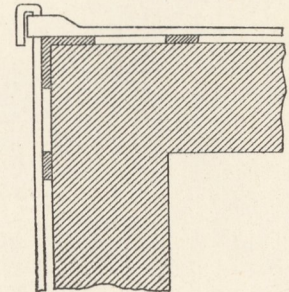

13. Zahnschloß.

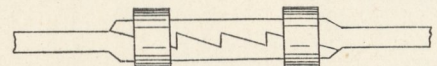

17. Gabelförmiges Keilschloß.

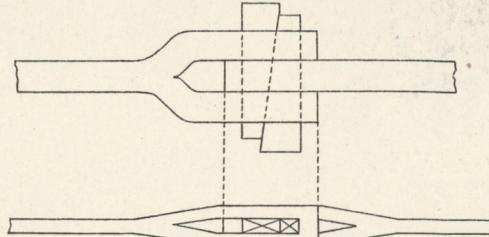

14. Kettenschloß.

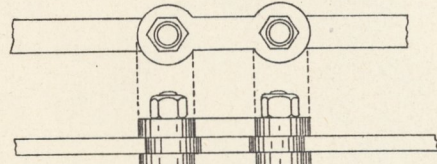

18. Gewöhnliches Keilschloß. (Siehe Fig. 9 Taf. 38.)

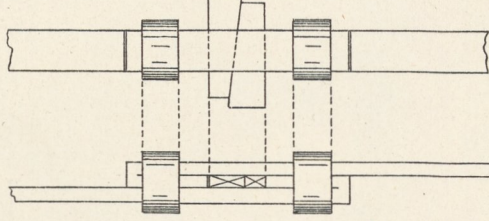

15. Schraubenschloß.

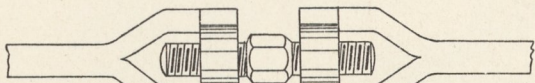

16. Muffenschloß.



16a. Muffenschloß (Holländische Schraube) mit Spannstangen.

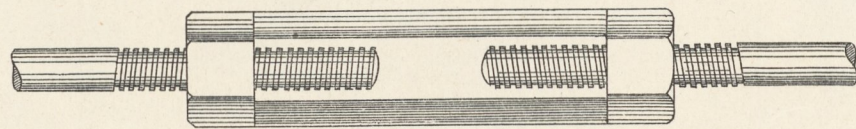

19. Anordnung der Zuganker.

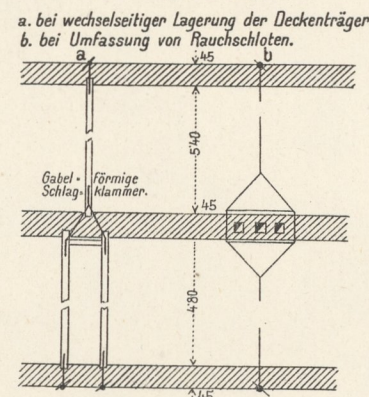

Detail zu Fig. 19, b.

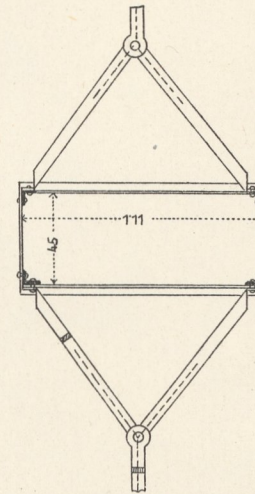

22. Eckanker.

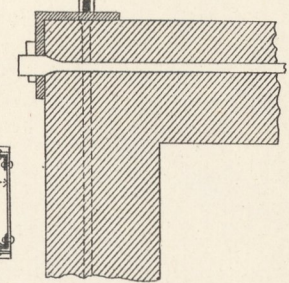

20. Passierung schließbarer Rauchschlote durch Schließen.

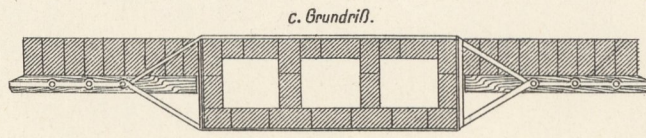

23. Eckanker.

