

# **281 Environmental assessment of power, district heating and district cooling geothermal generation for a neighborhood in Southern Italy**

**A. Maione<sup>1</sup>, R. Santagata<sup>1,\*</sup>, L. Vanoli<sup>1</sup>, N. Massarotti<sup>1</sup>**

*<sup>1</sup>Department of Engineering, Parthenope University of Naples, Centro Direzionale, Isola C4, 80143, Napoli, Italy*

*\*corresponding author: remo.santagata@assegnista.uniparthenope.it*

## **Abstract**

Global energy consumption has been characterized by rapid growth over the last decades, as a side effect of technological development and increased life style of some countries. Even though the recent COVID-19 pandemic set a fall of 5% in 2020, global energy demand is projected to reach pre-pandemic levels at the beginning of 2023 and to show a growth of 9% by 2030. Furthermore, the energy sector is one of the most relevant in terms of greenhouse gas (GHG) emissions, with electricity and heat production representing the largest contributor to global emissions (about 15 billion t in 2016). This framework advocates for solutions capable of addressing the global growing demand of energy with much reduced environmental impacts. The energy demand presents different rates worldwide, with a declining trend in advanced economies and an increased request in developing economies. However, energy inequality is still dramatically spread globally, with large dissimilarities both among countries and among income groups, with the top 10% earners consuming about 20 times more energy compared to the bottom 10%. The much advocated energy transition discourse from fossil-based to zero-carbon is led by the use of solar photovoltaic (PV) energy, representing the main driver of growth within the share of renewable energies. However, this change in the electricity sector translates in an additional pressure in the use of reliable supplies of crucial minerals and metals, as well as within the production, and the disposal of storage elements, such as accumulators and batteries.

Geothermal is a kind of energy always available in loco to be used through suitable plants. In this work, a geothermal system is proposed as a feasible addition for the generation of power, by means of an Organic Rankine Cycle (ORC), and for the generation of district heating and cooling for buildings. The presented case study is the

evaluation, by means of the Life Cycle Assessment (LCA) method, of a grid designed for the supply of heating and cooling to eight buildings in the city of Naples (Italy) and for the generation of electricity with a reduced generation of environmental impacts.

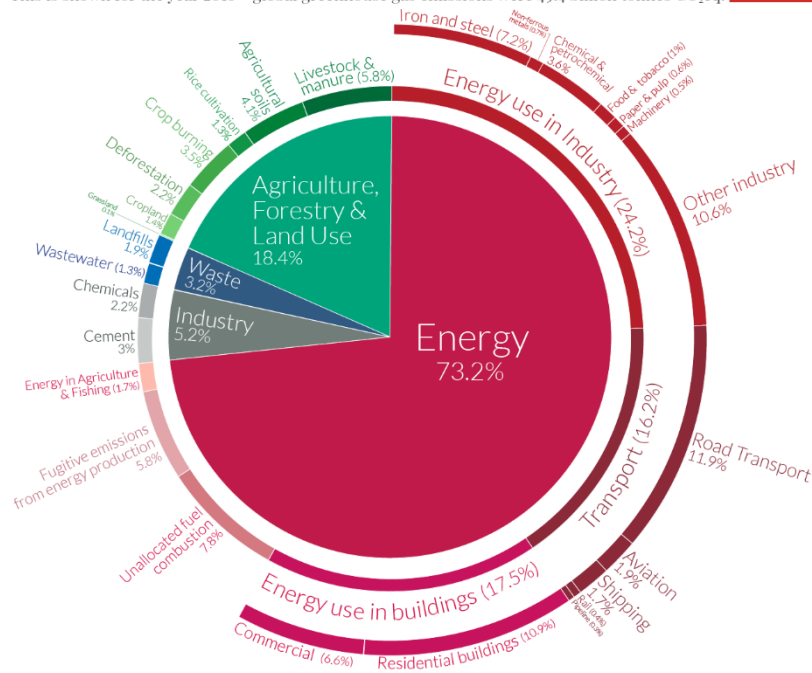
**Keywords:** Geothermal energy, Energy grid, Life Cycle Assessment, Organic Rankine Cycle, District Heating and Cooling

## Introduction

One of the main worldwide aims, in order to counteract the current environmental pressure, is a global reduction of anthropogenic greenhouse gases (GHG) emissions, as discussed within the United Nations Sustainable Development Goals (SDGs) (UN, 2018), the Intergovernmental Panel on Climate Change (IPCC) report (IPCC, 2018) and the United Nations Climate Change Conference of the Parties (COP) (UN, 2019). The document produced after the Rio+20 Conference, the Future We Want, highlights climate change as “an inevitable and urgent global challenge with long-term implications for the sustainable development of all countries” (UN, 2012). As set forth within the document, Member States acknowledged the importance of the ever growing emissions of GHG, in particular by developed countries, and the direct exposure to the problem and to the related dangerous effects of all countries, particularly developing countries. Therefore, Member States advocated for the cooperation and participation in significantly addressing the urgent issue of climate change. As part of the European Green Deal, the European Commission proposed a target of at least 55% reduction of GHG gases compared to 1990 by 2030 (EC, 2019). A significant part of the global GHG emissions, comes from the energy sector (Figure 1), making it the most important target to acknowledge for addressing the issue. The global production of electricity and heat have been responsible for the emission of about 15 million tonnes CO<sub>2</sub> eq. in 2016 (Ritchie and Roser, 2020a).

# Global greenhouse gas emissions by sector

This is shown for the year 2016 – global greenhouse gas emissions were 49.4 billion tonnes CO<sub>2</sub>eq.



OurWorldinData.org - Research and data to make progress against the world's largest problems.  
 Source: Climate Watch, the World Resources Institute (2020). Licensed under CC-BY by the author Hannah Ritchie (2020).

**Figure 1. Global 2016 GHG emissions by sector (source: <https://ourworldindata.org/emissions-by-sector>).**

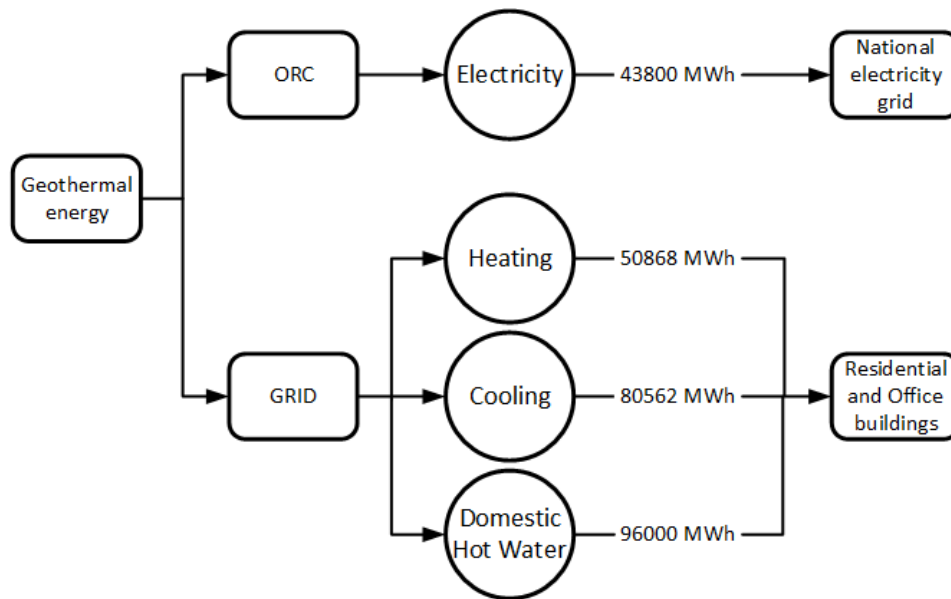
In the last half century, energy consumption has been growing yearly, with a fast raising trend in regions where incomes and population are growing, and actually declining trends in richer countries (Ritchie and Roser, 2020b). The global energy demand dropped of about 5% in 2020 because of the current COVID-19 pandemic, with a projected rebound to pre-pandemic levels at the beginning of 2023. In a scenario in which the pandemic is gradually controlled following the current policy objectives, the global energy demand is expected to grow by 9% within 2030 (IEA, 2020). Large relevance, to reach the decarbonization objective, is given to photovoltaic (PV) systems. Global PV capacity is expected to grow, from a current installed capacity of about 655 GW (IEEFA, 2019), to an expected 4500 GW by 2050 (IRENA, 2016). This will cause 78 million tons of PV waste by 2050, a figure which the vast majority of the global countries are unable to deal with, from a material and a regulatory point of view (Ghosh and Yadav, 2021). Even though a minimum level of energy consumption is a fundamental requirement for an adequate wellbeing, energy inequality is still dramatically spread across countries and income groups, with many people suffering from energy deprivation and very few consuming far too much, as the final energy consumption of the top 10% income earners is equal to roughly 20 times more compared to the lowest 10% (Oswald et al., 2020).

This situation calls for energy sources simultaneously capable of addressing these environmental, social and economic issues.

In this work, a geothermal system, namely the GEOGRID system, for the generation at low environmental impacts of electric energy delivered to the national electricity grid and of district heating, cooling and domestic hot water delivered to eight buildings in the Municipality of Napoli is proposed and assessed by means of the Life Cycle Assessment (LCA) method. The system, proposed under a R&D project funded by Campania region with EU funding, addresses the sustainable use of geothermal energy in Southern Italy.

## **Materials and methods**

The investigated case study is a geothermal plant for the production of electricity by means of an Organic Rankine Cycle (ORC) system, and the production and delivering of district heating, cooling and domestic hot water to 5 residential buildings and 3 office buildings in a neighborhood in the municipality of Naples, Italy, by sustainably exploiting the geothermal energy available (Figure 2). The geothermal fluid extracted is directed to a first heat exchanger, for the ORC system, and then to a second heat exchanger, for the district heating and cooling grid. Cooling energy is generated by means of an absorption chiller. Heating and cooling energy is delivered to the buildings with dedicated pipes. The geothermal fluid is reheated to adequate levels by using excess heat from the system before reinjecting it in the underground. The entire system is able to generate 43800 MWh of electric energy, 50868 MWh as heating, 80562 MWh as cooling and 96000 MWh as domestic hot water over the course of 20 years. The heating and cooling energy production is based on the energy demand of the served buildings, however the investigated system would be capable of supplying energy to additional buildings connected to the grid.



**Figure 2. Flow chart of the GEOGRID system.**

The environmental assessment of the impacts and use of resources of the investigated system over its the entire lifespan, estimated in 20 years, has been performed by means of the LCA method. LCA is a four-step tool for the assessment of human driven transformation activities (ISO, 2006a, 2006b), standardized as: 1) goal and scope definition: the boundaries and functional unit (FU) of the study are defined; 2) Life Cycle Inventory (LCI) analysis: the inventory of all input and output flows is defined; 3) Life Cycle Impact Assessment (LCIA): impact and resource use indicators for the selected case study are calculated; 4) Interpretation of results.

This study has been conducted using the SimaPro v.9.1.1.1 software (<https://simapro.com/>), the Ecoinvent v.3.6 database (Wernet et al., 2016) and the ReCiPe 2016 v1.04 Midpoint and Endpoint impact method (Goedkoop et al., 2009; Huijbregts et al., 2017).

## Results and Discussion

### ORC system

The ORC system inventory has been built based on Wang et al. (2020), considering an installed power of 0.5 MW, with a cooling tower modeled following Schulze et al. (2019), and heat exchangers, modeled based on technical specifications (inventory in Table 1).

**Table 1. LCI of construction and operation of the ORC system.**

#	Item	Quantity	Unit
Input			
1	Geothermal wells (× 2)	80	m
2	Excavation operation	1075.5	m <sup>3</sup>
3	Filling	1640774	kg
4	Cement	44.5	m <sup>3</sup>
5	Steel	17909.5	kg
6	Stainless steel	1651	kg
7	Aluminum	438	kg
8	Copper	297.5	kg
9	Rock wool	443.5	kg
10	High density polyethylene	219.8	kg
11	Polyvinylchloride	143.2	kg
12	Water	452050	kg
13	Titanium	296.5	kg
14	Glass fiber reinforced plastic	1277.5	kg
15	Refrigerant	5780	kg
16	Cooling tower	1	item
17	Disposal of end-of-life materials		
18	Geothermal energy	438000	MWh
Output			
19	Electricity	43800	MWh
20	Thermal energy returned to environment	44045	MWh

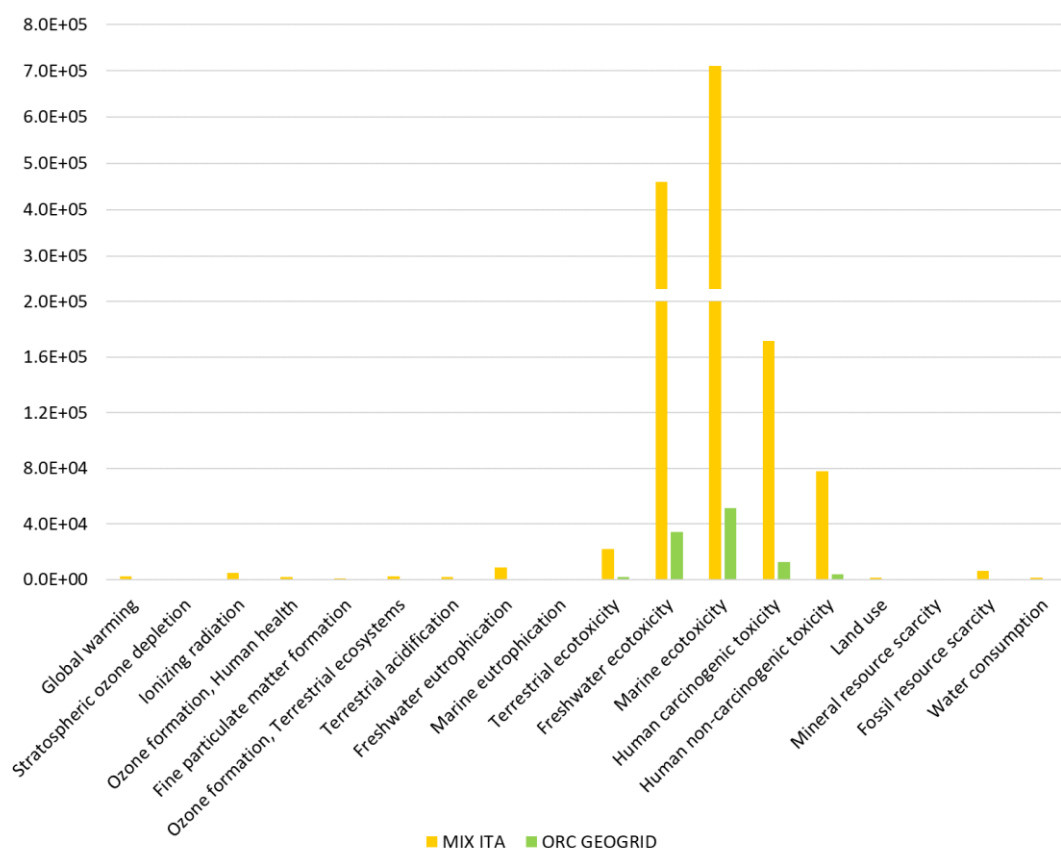
In Table 2, the ReCiPe Midpoint characterized results are reported for the generation of 43800 MWh of electric energy over the timespan of 20 years. These numbers are largely due to the extraction and processing of metals used within the machinery involved.

**Table 2. ReCiPe 2016 v1.04 Midpoint characterized results for the generation of 43800 MWh from the ORC system.**

Impact category	Unit	Quantity
Global warming	kg CO <sub>2</sub> eq	2.5E+05
Stratospheric ozone depletion	kg CFC11 eq	3.9E+00
Ionizing radiation	kBq Co-60 eq	1.1E+04
Ozone formation, Human health	kg NO <sub>x</sub> eq	6.8E+02
Fine particulate matter formation	kg PM2.5 eq	4.4E+02
Ozone formation, Terrestrial ecosystems	kg NO <sub>x</sub> eq	7.1E+02
Terrestrial acidification	kg SO <sub>2</sub> eq	8.8E+02
Freshwater eutrophication	kg P eq	9.0E+01

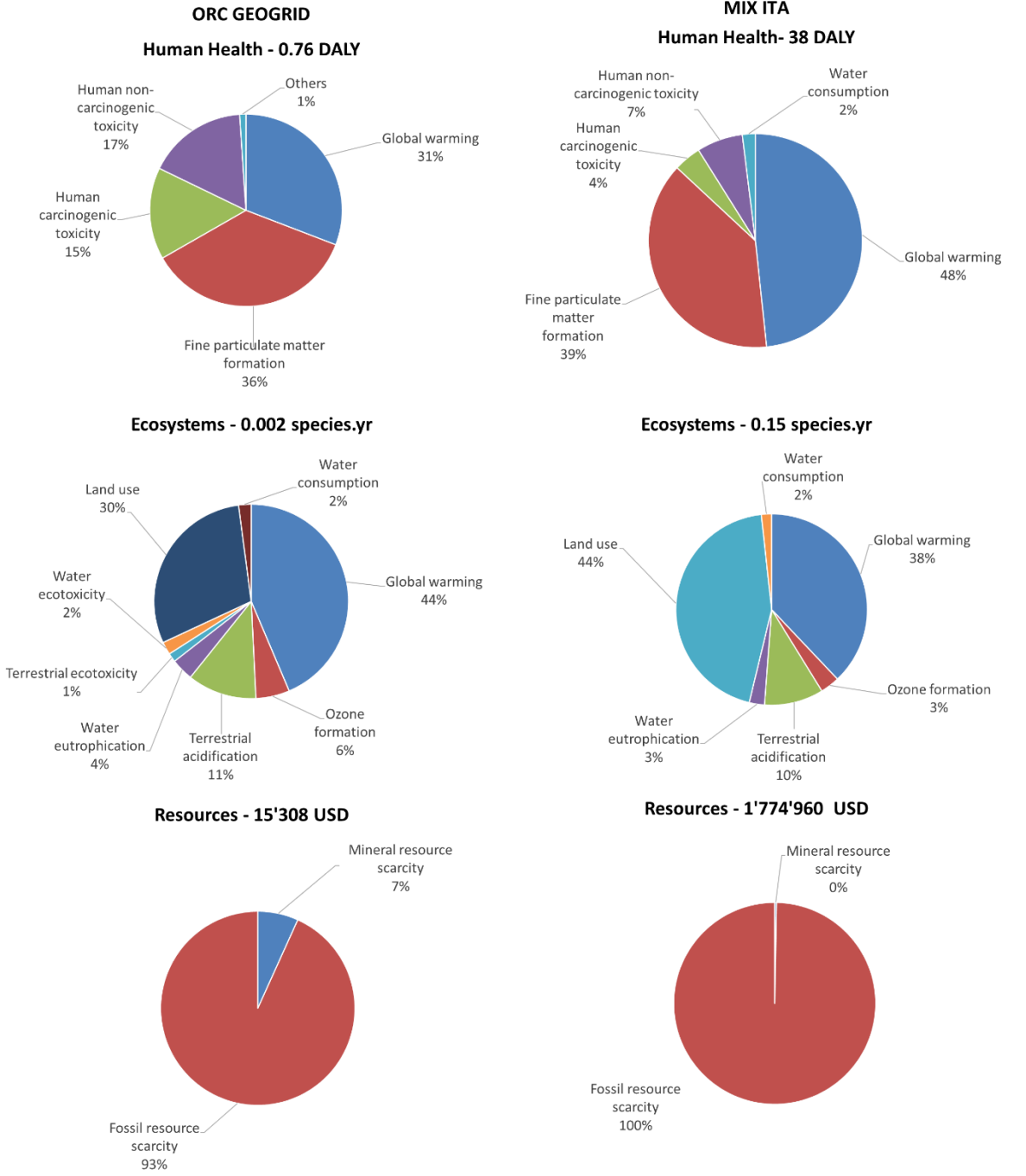
Marine eutrophication	kg N eq	9.0E+00
Terrestrial ecotoxicity	kg 1,4-DCB	2.1E+06
Freshwater ecotoxicity	kg 1,4-DCB	4.2E+04
Marine ecotoxicity	kg 1,4-DCB	5.3E+04
Human carcinogenic toxicity	kg 1,4-DCB	3.6E+04
Human non-carcinogenic toxicity	kg 1,4-DCB	5.6E+05
Land use	m <sup>2</sup> a crop eq	5.5E+04
Mineral resource scarcity	kg Cu eq	4.5E+03
Fossil resource scarcity	kg oil eq	4.7E+04
Water consumption	m <sup>3</sup>	3.1E+03

Figure 3 shows the normalized results for the ORC electricity generation compared to the same amount of energy from the Italian national grid of electricity. The impacts of the ORC generation of electricity are about 95% lower than the impacts from the Italian electricity mix on average across the impact categories, highlighting the higher impacts of an electricity production heavily relying on the combustion of fossil fuels as the Italian mix, composed for about 40% by the combustion of natural gas and for about 10% by the combustion of coal, among other contributions.



**Figure 3. ReCiPe 2016 v1.04 Midpoint normalized results for the generation of 43800 MWh from the ORC system and from the Italian mix of electricity.**

From an Endpoint perspective (Figure 4), the impacts of the investigated ORC system on human health are equal to the 2% of those from the Italian mix, the impacts on ecosystems are 1.3% of those from the Italian mix, while the impact of resources of the investigated system is represents the 0.8% of that related to the Italian mix of electricity.



**Figure 4. ReCiPe 2016 v1.04 Endpoint impacts for the generation of 43800 MWh from the ORC system and the Italian electricity mix.**



## Grid for district heating, cooling and domestic hot water

The proposed grid (GEOGRID) would provide 3 office buildings and 5 residential buildings with heating and cooling energy and with domestic hot water, following their energy demand. The system is designed with extraction and re-injection wells shared with the ORC system, a 10 MW heat exchanger, a 7.5 MW absorption chiller, a cooling tower, 1.6 km of insulated PVC pipes, a substation with three heat exchangers for each served building and an adequate number of fan coils within the buildings (Table 3).

**Table 3. LCI of construction and operation of the grid system.**

#	Item	Quantity	Unit
Input			
1	Geothermal wells (x2)	80	m
2	Steel	14842	kg
3	Cooling tower	1	item
4	Absorption chiller		
	<i>Steel</i>	11340	kg
	<i>Copper</i>	4860	kg
	<i>LiBr solution</i>	2280	kg
5	Grid pipes	1600	km
	<i>PVC</i>	128.32	kg/m
	<i>Bitumen</i>	81	kg/m
	<i>Insulator</i>	7.54	kg/m
	<i>Excavation</i>	4.2	m <sup>3</sup> /m
6	Fan coil	1159	item
	<i>Steel</i>	17.38	kg/item
	<i>Copper</i>	3.92	kg/item
	<i>Aluminum</i>	1.4	kg/item
	<i>PVC</i>	0.3	kg/item
8	Building pipes	22.25	km
	<i>HDPE</i>	4.5	kg/m
9	Geothermal energy	696000	MWh
10	Water	7507.3	m <sup>3</sup>
11	Disposal of end-of-life material		
12	Wastewater treatment	6209.2	m <sup>3</sup>
Output			
13	Heating	50867.8	MWh
14	Cooling	80561.8	MWh
15	Domestic hot water	96000	MWh
16	Thermal energy returned to environment	3650	MWh

Residential buildings are served with 3.5E+4 MWh as heating, 5.6E+4 MWh as cooling and 6.0E+4 MWh as domestic hot water, over the considered lifespan of 20 years. The midpoint results reported in Table 4 are largely due to the extraction and processing of metal ( $\approx 60\%$  of impacts) and plastics ( $\approx 15\%$  of impacts). The larger impacts, about 39%, are related to the cooling energy.

**Table 4. ReCiPe 2016 v1.04 Midpoint characterized results for the energies used by the residential buildings in 20 years.**

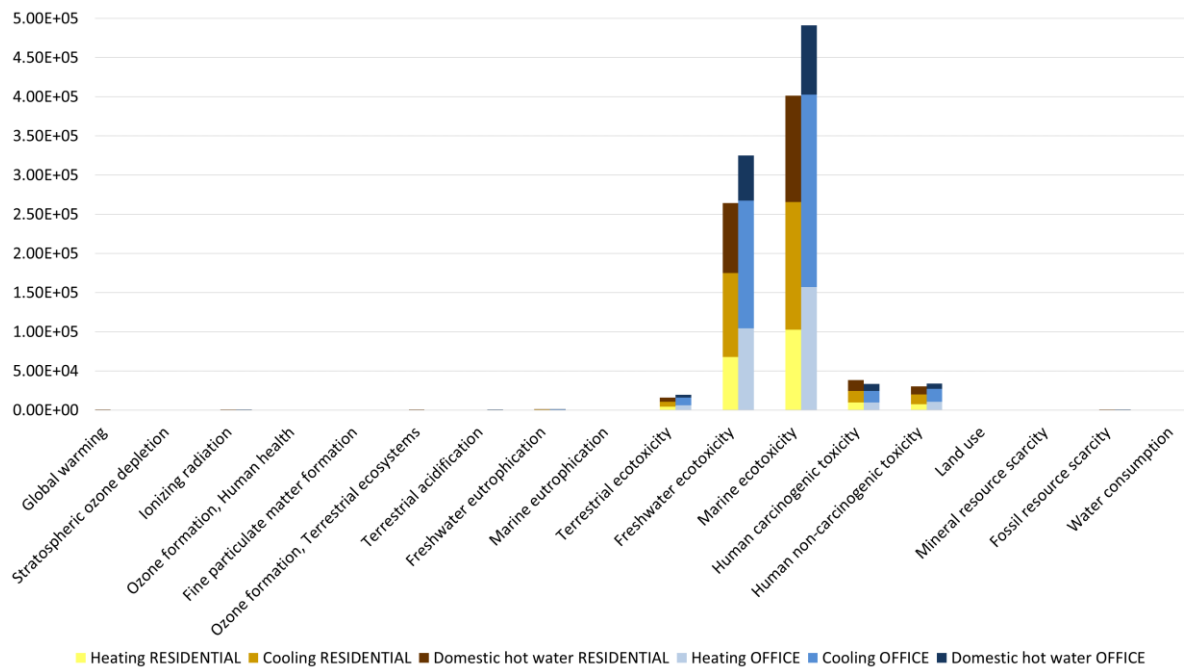
Impact category	Unit	TOTAL	Heating	Cooling	Domestic hot water
Global warming	kg CO <sub>2</sub> eq	1.2E+06	2.8E+05	4.4E+05	4.6E+05
Stratospheric ozone depletion	kg CFC11 eq	6.9E-01	1.6E-01	2.6E-01	2.7E-01
Ionizing radiation	kBq Co-60 eq	8.0E+04	1.9E+04	3.0E+04	3.1E+04
Ozone formation, Human health	kg NO <sub>x</sub> eq	2.5E+03	5.9E+02	9.3E+02	9.4E+02
Fine particulate matter formation	kg PM2.5 eq	2.2E+03	5.4E+02	8.5E+02	8.2E+02
Ozone formation, Terrestrial ecosystems	kg NO <sub>x</sub> eq	2.6E+03	6.1E+02	9.6E+02	9.8E+02
Terrestrial acidification	kg SO <sub>2</sub> eq	4.9E+03	1.2E+03	1.9E+03	1.8E+03
Freshwater eutrophication	kg P eq	5.7E+02	1.4E+02	2.3E+02	2.0E+02
Marine eutrophication	kg N eq	2.3E+02	5.3E+01	8.4E+01	8.9E+01
Terrestrial ecotoxicity	kg 1,4-DCB	1.7E+07	4.2E+06	6.7E+06	5.6E+06
Freshwater ecotoxicity	kg 1,4-DCB	3.2E+05	8.3E+04	1.3E+05	1.1E+05
Marine ecotoxicity	kg 1,4-DCB	4.1E+05	1.1E+05	1.7E+05	1.4E+05
Human carcinogenic toxicity	kg 1,4-DCB	1.1E+05	2.7E+04	4.1E+04	3.9E+04
Human non-carcinogenic toxicity	kg 1,4-DCB	4.5E+06	1.1E+06	1.8E+06	1.6E+06
Land use	m <sup>2</sup> a crop eq	5.0E+05	1.3E+05	2.0E+05	1.8E+05
Mineral resource scarcity	kg Cu eq	1.5E+04	3.8E+03	6.0E+03	5.5E+03
Fossil resource scarcity	kg oil eq	4.4E+05	1.0E+05	1.6E+05	1.7E+05
Water consumption	m <sup>3</sup>	2.1E+04	5.0E+03	8.0E+03	8.4E+03

Office buildings are provided 1.6E+04 MWh as heating, 2.5E+04 MWh as cooling and 3.6E+04 MWh as domestic hot water. The midpoint impact results are listed in Table 5. 43% average of impacts are related to the cooling energy, and the contributions are in line with the contributions to the energy for residential buildings, mostly coming from the metal and plastic materials used.

**Table 5. ReCiPe 2016 v1.04 Midpoint characterized results for the energies used by the office buildings in 20 years**

Impact category	Unit	TOTAL	Heating	Cooling	Domestic hot water
Global warming	kg CO <sub>2</sub> eq	8.2E+05	1.8E+05	2.9E+05	3.4E+05
Stratospheric ozone depletion	kg CFC11 eq	4.6E-01	1.1E-01	1.8E-01	1.7E-01
Ionizing radiation	kBq Co-60 eq	5.7E+04	1.4E+04	2.2E+04	2.1E+04
Ozone formation, Human health	kg NO <sub>x</sub> eq	1.8E+03	4.5E+02	7.0E+02	6.4E+02
Fine particulate matter formation	kg PM2.5 eq	1.8E+03	5.1E+02	7.9E+02	5.3E+02
Ozone formation, Terrestrial ecosystems	kg NO <sub>x</sub> eq	1.9E+03	4.7E+02	7.3E+02	6.7E+02
Terrestrial acidification	kg SO <sub>2</sub> eq	4.3E+03	1.2E+03	1.9E+03	1.2E+03
Freshwater eutrophication	kg P eq	5.7E+02	1.7E+02	2.7E+02	1.3E+02
Marine eutrophication	kg N eq	1.4E+02	3.0E+01	4.7E+01	5.8E+01
Terrestrial ecotoxicity	kg 1,4-DCB	2.0E+07	6.5E+06	1.0E+07	3.5E+06
Freshwater ecotoxicity	kg 1,4-DCB	4.0E+05	1.3E+05	2.0E+05	7.1E+04
Marine ecotoxicity	kg 1,4-DCB	5.1E+05	1.6E+05	2.5E+05	9.1E+04
Human carcinogenic toxicity	kg 1,4-DCB	9.2E+04	2.6E+04	4.1E+04	2.5E+04
Human non-carcinogenic toxicity	kg 1,4-DCB	5.0E+06	1.6E+06	2.5E+06	1.0E+06
Land use	m <sup>2</sup> a crop eq	4.9E+05	1.5E+05	2.3E+05	1.1E+05
Mineral resource scarcity	kg Cu eq	1.4E+04	4.2E+03	6.5E+03	3.4E+03
Fossil resource scarcity	kg oil eq	3.0E+05	6.7E+04	1.0E+05	1.3E+05
Water consumption	m <sup>3</sup>	1.3E+04	2.9E+03	4.6E+03	5.5E+03

Figure 5 shows the normalized impacts for the energies delivered by the geothermal grid. The larger impacts are within toxicity related categories (marine ecotoxicity, freshwater ecotoxicity, human carcinogenic and non-carcinogenic toxicity and terrestrial ecotoxicity), and are due to the extraction and processing of materials used, with the office energies being slightly larger because of the high number of fan coils used in the office buildings (970 fan coils in office buildings on a total number of 1159).



**Figure 5. ReCiPe 2016 v1.04 Midpoint normalized results for the heating, cooling and domestic hot water energy to residential and office buildings in 20 years.**

The obtained results for the designed grid have been compared to some scenarios for the delivering of the same amount of energy to the considered buildings.

**Scenario 1:** the current situation, with boilers for heating and domestic hot water and air conditioning for cooling in residential buildings, and heat pumps for heating and cooling and boilers for domestic hot water in office buildings.

The investigated geothermal grid shows impacts reduced of average 82% in residential buildings and 74% in office buildings compared to Scenario 1, with the avoided emission of 52000 tons of CO<sub>2</sub> eq., 25 tons of PM2.5, 300'000 m<sup>3</sup> less water used and 16'000 tons less oil<sub>eq.</sub>.

**Scenario 2:** in both residential and office buildings, heat pumps are used for heating and cooling and boilers are used for domestic hot water.

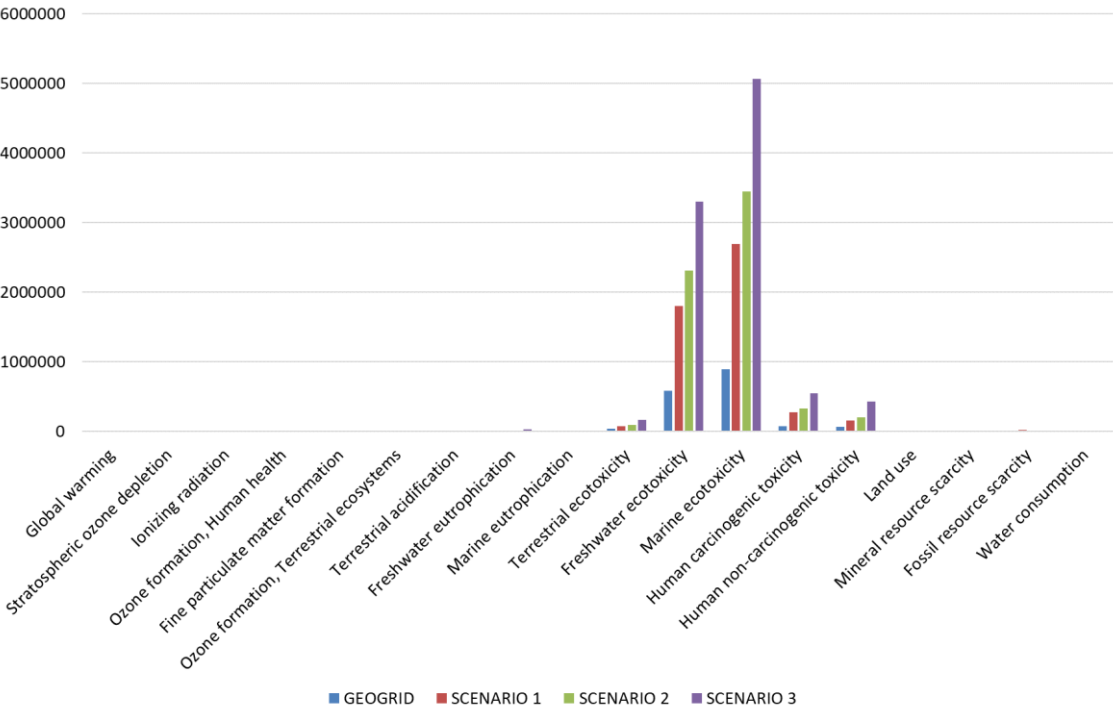
Impacts of the geothermal grid are 86% and 74% lower for respectively residential and office buildings, with less 49000 tons of CO<sub>2</sub> eq., 30 tons of PM2.5, 406'000 m<sup>3</sup> less water used and 14'500 tons less oil<sub>eq.</sub>.

**Scenario 3:** same configuration as Scenario 2, but with PV electricity powering the heat pumps and biogas used in the boilers.

In this scenario, the geothermal grid shows 90% less impacts for the residential buildings and 84% for the office buildings, with avoided 32000 tons of CO<sub>2</sub> eq., 20 tons of PM2.5, 1.5 million m<sup>3</sup> water used and 1500 tons of oil<sub>eq.</sub>. Scenario 3 show reduced

impacts in terms of use of fossil resources and emission of CO2 compared to Scenario 1 and Scenario 2, but higher impacts on the other categories because of the mainly agricultural operations providing the biomass for biogas generation.

Figure 6 shows the normalized impacts related to the entire energy production from the proposed geothermal grid, and from the three developed scenarios, highlighting the environmental benefits delivered by the GEOGRID system.



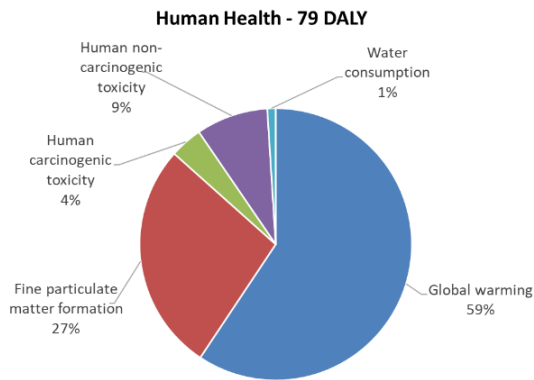
**Figure 6. ReCiPe 2016 v1.04 Midpoint normalized results for the proposed geothermal grid, Scenario 1, Scenario 2 and Scenario 3.**

From an endpoint perspective, the comparison among the GEOGRID system and the developed scenarios (Figures 7a and 7b) shows the difference of a system within which energy is not generated by the combustion of resources, both renewable and non-renewable. As already said, the impacts of the GEOGRID system are related to the extraction and processing of materials (metals and plastics) used in the plant and machinery, while the three scenarios are affected by a high reliance on combustion processes, even when PV electricity is involved, because of the activities of production of PV systems. Human health effects of the proposed grid are 1/10 of those of the developed scenarios. Ecosystems effects are 1/10 compared to Scenario 1 and 2 and 1/20 compared to Scenario 3. Resources impacts of the GEOGRID system are 5% compared to Scenario 1 and 2 and 38% compared to Scenario 3.

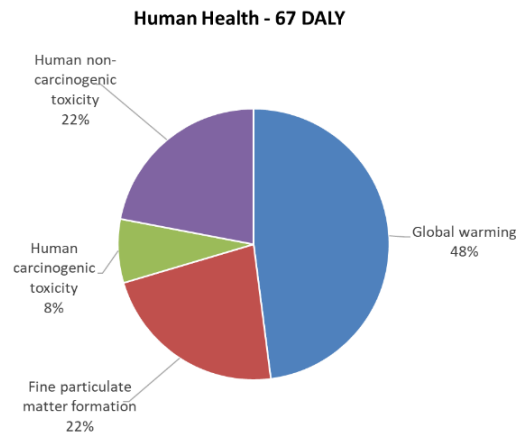


**Figure 7a. ReCiPe 2016 v1.04 Endpoint impacts for the energies generated in 20 years by the GEOGRID system and the same amounts from SCENARIO 1.**

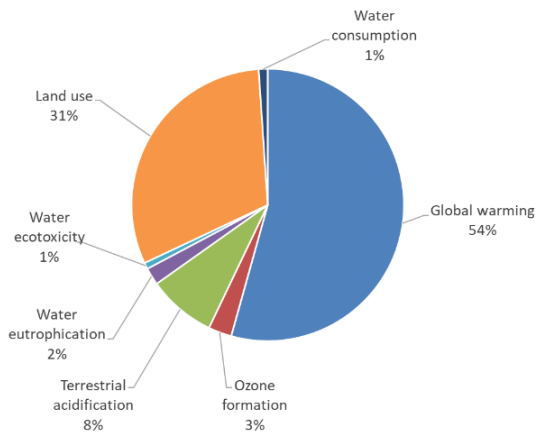
**SCENARIO 2**



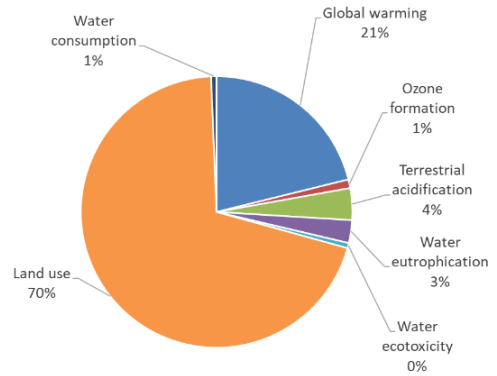
**SCENARIO 3**



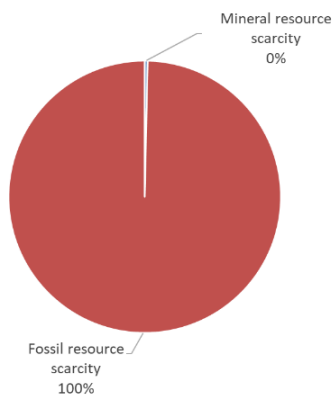
**Ecosystems - 0.26 species.yr**



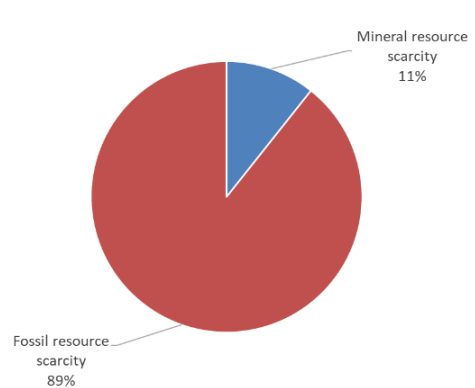
**Ecosystems - 0.46 species.yr**



**Resources - 5'039'984 USD**



**Resources - 725'086 USD**



**Figure 7b. ReCiPe 2016 v1.04 Endpoint impacts for the generation in SCENARIO 2 and SCENARIO 3 of the same amount of energies generated by the GEOGRID system in 20 years.**

## Conclusions

The proposed GEOGRID system for the sustainable use of the geothermal resource at low and medium enthalpy for the generation of electric energy, district heating, cooling and domestic hot water has been assessed as a feasible way of ideally addressing pollution, climate change, energy scarcity and energy inequality issues at the same time. Being characterized by the total absence of combustion processes and a by stable availability of the energy source (i.e. the geothermal fluid), it showed a reliable energy source at low environmental impacts, when compared to current and improved energy sources. Furthermore, if taking in consideration the economic aspects too, it would be important to consider that the served buildings could be interested by interventions for their improvements in terms of thermal insulation, renewal of air conditioning systems and energy efficiency, among others, under the incentives contained in the Italian regulation D.L. 34, active from the May 19th, 2020 (DECRETO-LEGGE 19 maggio 2020, n. 34, 2020). These interventions are estimated at around 4 million € in total for the residential and office buildings involved in the investigated system. The construction of the considered buildings dates back to around the 1960s and 1970s, thus presenting a short residual lifespan of around 20 years, which is not allowing for a complete amortization of the investment. A rough estimate of the implementation of the GEOGRID system is calculated at 2 million €. Therefore, the advantage would be represented by the halved cost for a system that will continue to stay in place delivering energy even if the connected buildings will theoretically be replaced. Furthermore, the energy generated as district heating, cooling and district hot water has been assessed based on the demand of the involved buildings, but the system is theoretically capable of producing additional energy for additional buildings to become part of the grid, configuring as a real energy community.

## Acknowledgements

The Authors gratefully acknowledge the partial support from the project “Geogrid – Tecnologie e sistemi innovativi per l'utilizzo sostenibile dell'energia geotermica”, CUP B43D18000230007, Distretti ad Alta Tecnologia, Aggregazioni e Laboratori Pubblico Privati per il rafforzamento del potenziale scientifico e tecnologico della Regione Campania concessione contributo, a titolo di aiuto ad hoc, DECRETO DI CONCESSIONE N. 29 del 29/11/2018, Giunta Regionale della Campania.

## References

DECRETO-LEGGE 19 maggio 2020, n. 34, 2020.

EC, 2019. Communication from the Commission - The European Green Deal.



Ghosh, S., Yadav, R., 2021. Future of photovoltaic technologies: A comprehensive review. *Sustain. Energy Technol. Assessments* 47, 101410. <https://doi.org/10.1016/J.SETA.2021.101410>

Goedkoop, M., Heijungs, R., Huijbregts, M., DeSchryver, A., Struijs, J., VanZelm, R., 2009. ReCiPe 2008 — a life cycle impact assessment method which comprises harmonised category indicators at the midpoint and the endpoint level. Report I: Characterisation. Den Haag.

Huijbregts, M.A.J., Steinmann, Z.J.N., Elshout, P.M.F., Stam, G., Verones, F., Vieira, M.D.M., Hollander, A., Zijp, M., Zelm, R. van, 2017. ReCiPe 2016 v1.1 A harmonized life cycle impact assessment method at midpoint and endpoint level Report I: Characterization. Bilthoven, The Netherlands.

IEA (2020), *World Energy Outlook 2020*, IEA, Paris <https://www.iea.org/reports/world-energy-outlook-2020>

IEEFA, 2019. BNEF estimates new global solar installations in 2019 at 125GW, or more - Institute for Energy Economics & Financial Analysis [WWW Document]. URL <https://ieefa.org/bnef-estimates-new-global-solar-installations-in-2019-at-125gw-or-more/> (accessed 7.29.21).

IPCC, 2018. Global warming of 1.5° C: an IPCC special report on the impacts of global warming of 1.5° C above pre-industrial levels and related global greenhouse gas emission pathways, in the context of strengthening the global response to the threat of climate change. Intergovernmental Panel on Climate Change.

IRENA, 2016. End-Of-Life Management: Solar Photovoltaic Panels. Int. Renew. Energy Agency Int. Energy Agency Photovolt. Power Syst.

ISO, 2006a. UNI EN ISO 14040 - Environmental management - Life cycle assessment - Principles and framework.

ISO, 2006b. UNI EN ISO 14044: Life cycle assessment — Requirements and guidelines.

Oswald, Y., Owen, A., Steinberger, J.K., 2020. Large inequality in international and intranational energy footprints between income groups and across consumption categories. *Nat. Energy* 2020 53 5, 231–239. <https://doi.org/10.1038/s41560-020-0579-8>

Ritchie, H., Roser, M., 2020a. Emissions by sector [WWW Document]. Our World Data. URL <https://ourworldindata.org/emissions-by-sector#energy-electricity-heat-and-transport-73-2> (accessed 8.4.21).

Ritchie, H., Roser, M., 2020b. Energy [WWW Document]. Our World Data. URL <https://ourworldindata.org/energy> (accessed 7.30.21).

Schulze, C., Thiede, S., Herrmann, C., 2019. Life Cycle Assessment of Industrial Cooling Towers, Sustainable Production, Life Cycle Engineering and Management. Springer International Publishing. [https://doi.org/10.1007/978-3-319-92237-9\\_15](https://doi.org/10.1007/978-3-319-92237-9_15)

UN, 2019. Report of the Conference of the Parties on its twenty-fourth session, held in Katowice from 2 to 15 December 2018.

UN, 2018. THE 17 GOALS - Sustainable Development [WWW Document]. URL <https://sdgs.un.org/goals> (accessed 7.28.21).

UN, 2012. Resolution adopted by the General Assembly on 27 July 2012 - Future We Want.

Wang, Y., Du, Y., Wang, J., Zhao, J., Deng, S., Yin, H., 2020. Comparative life cycle assessment of geothermal power generation systems in China. *Resour. Conserv. Recycl.* 155, 104670. <https://doi.org/10.1016/j.resconrec.2019.104670>

Wernet, G., Bauer, C., Steubing, B., Reinhard, J., Moreno-Ruiz, E., Weidema, B., 2016. The ecoinvent database version 3 (part I): overview and methodology. *Int. J. Life Cycle Assess.* pp.1218–1230.