

- a } = Scatsparren
- b }
- c }
- d }
- f = Firstlinie
- o = Saumlinie
- △ = Wagziß

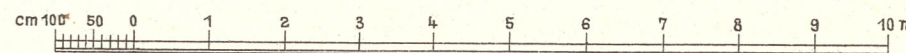

1:100

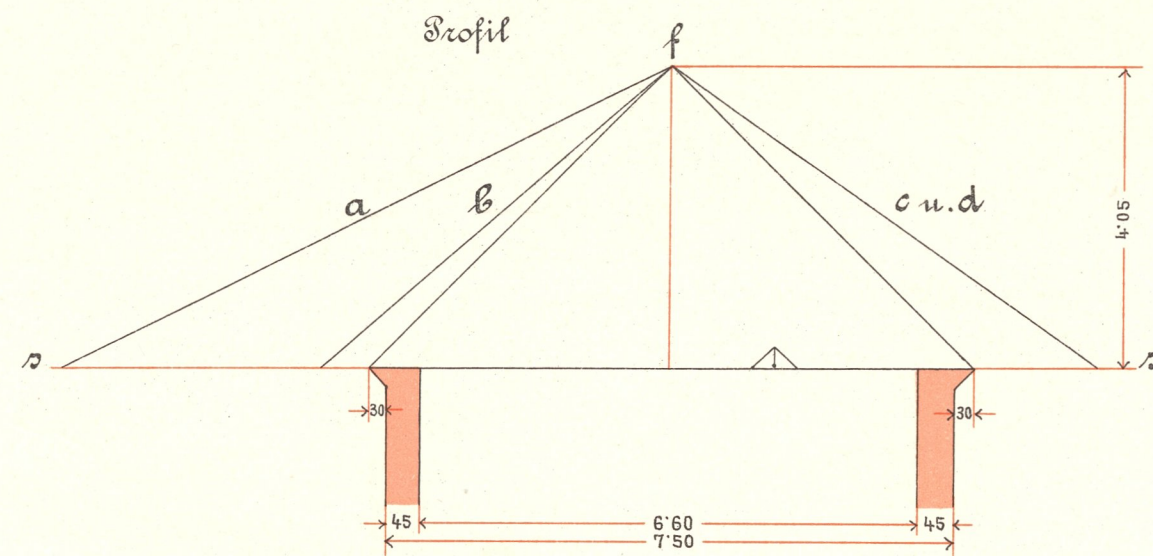

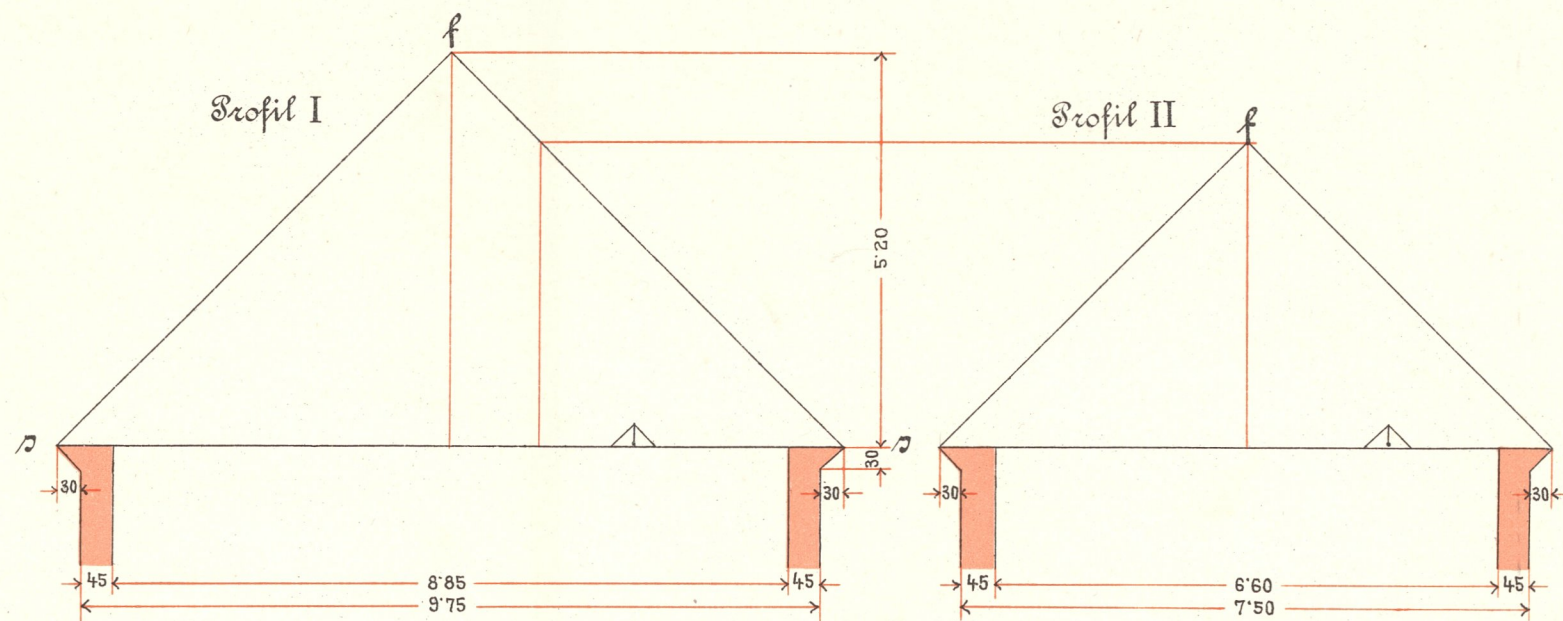
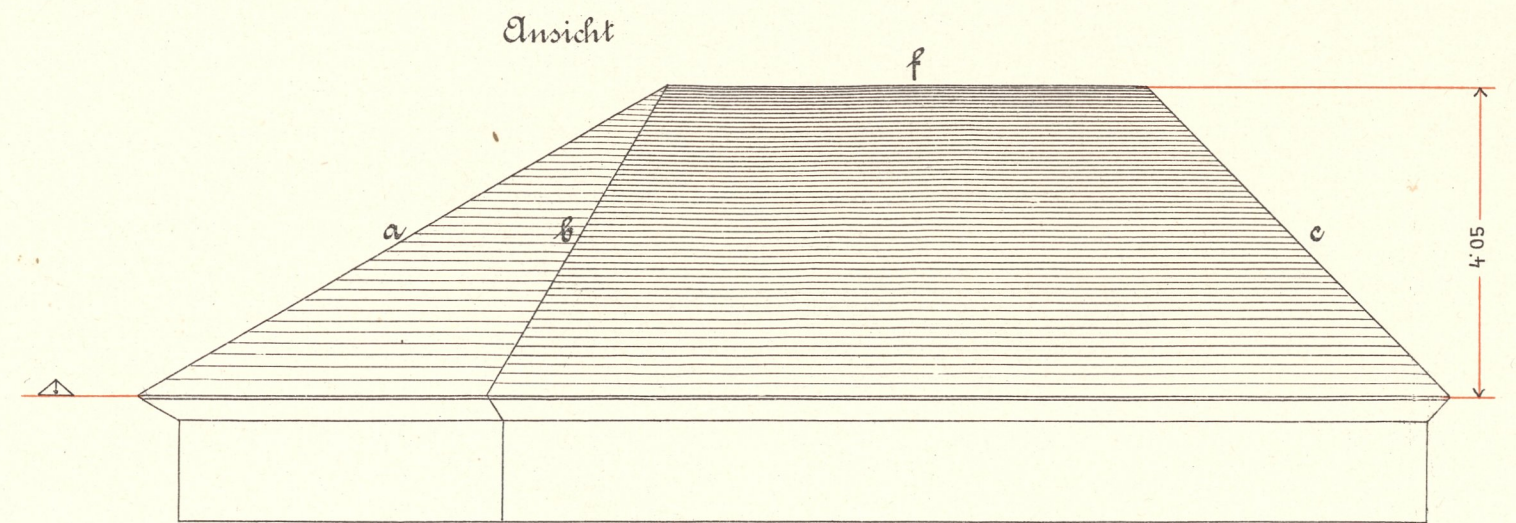
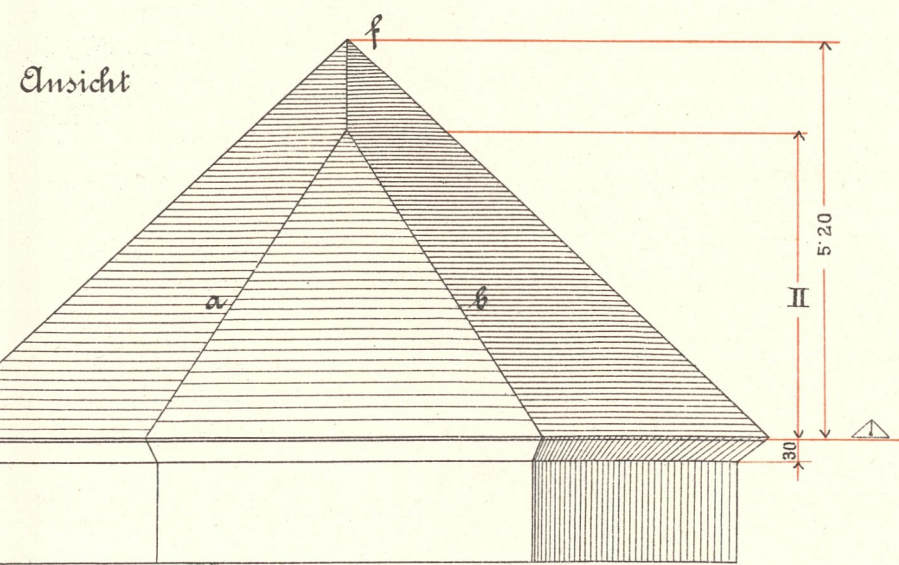

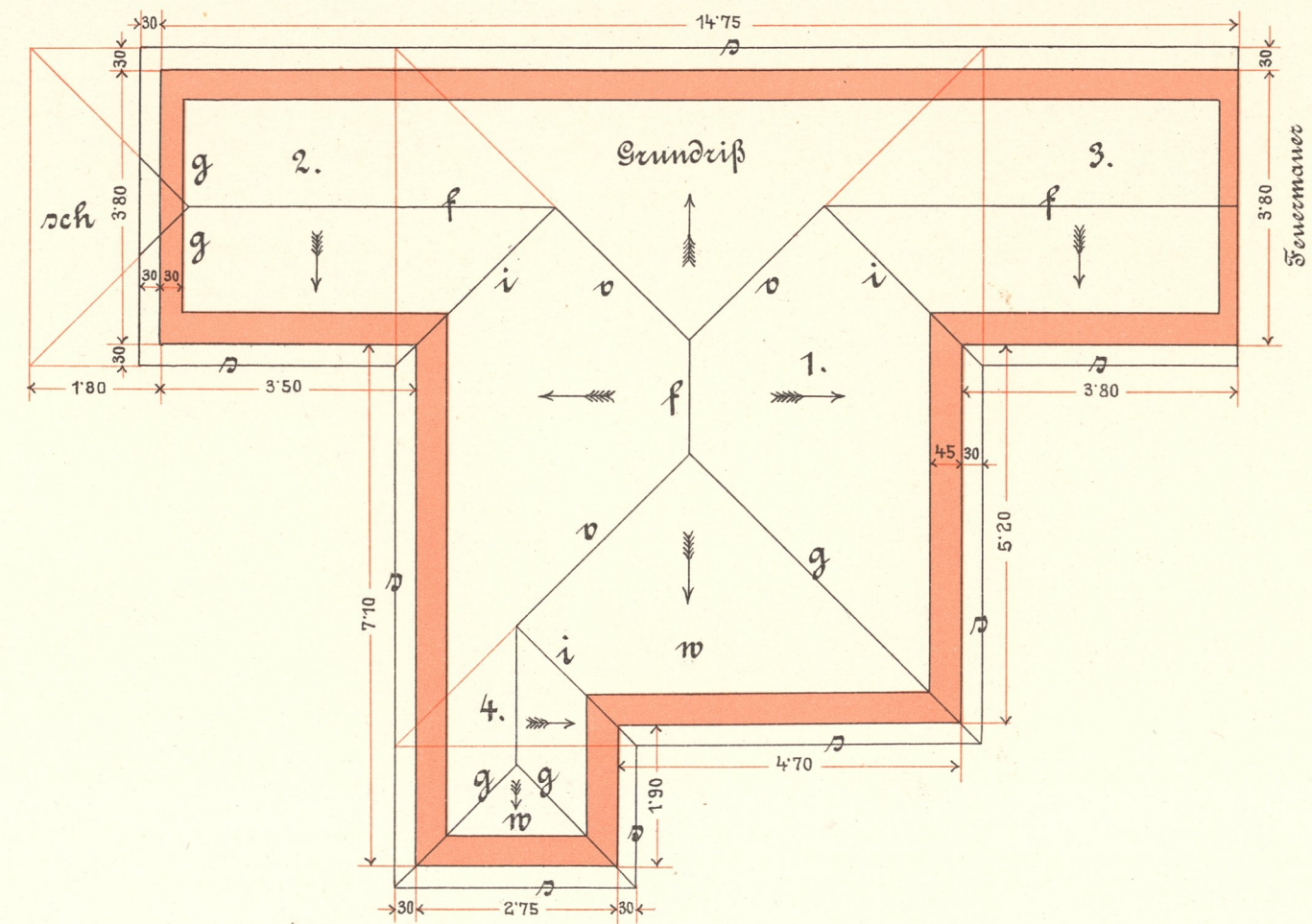
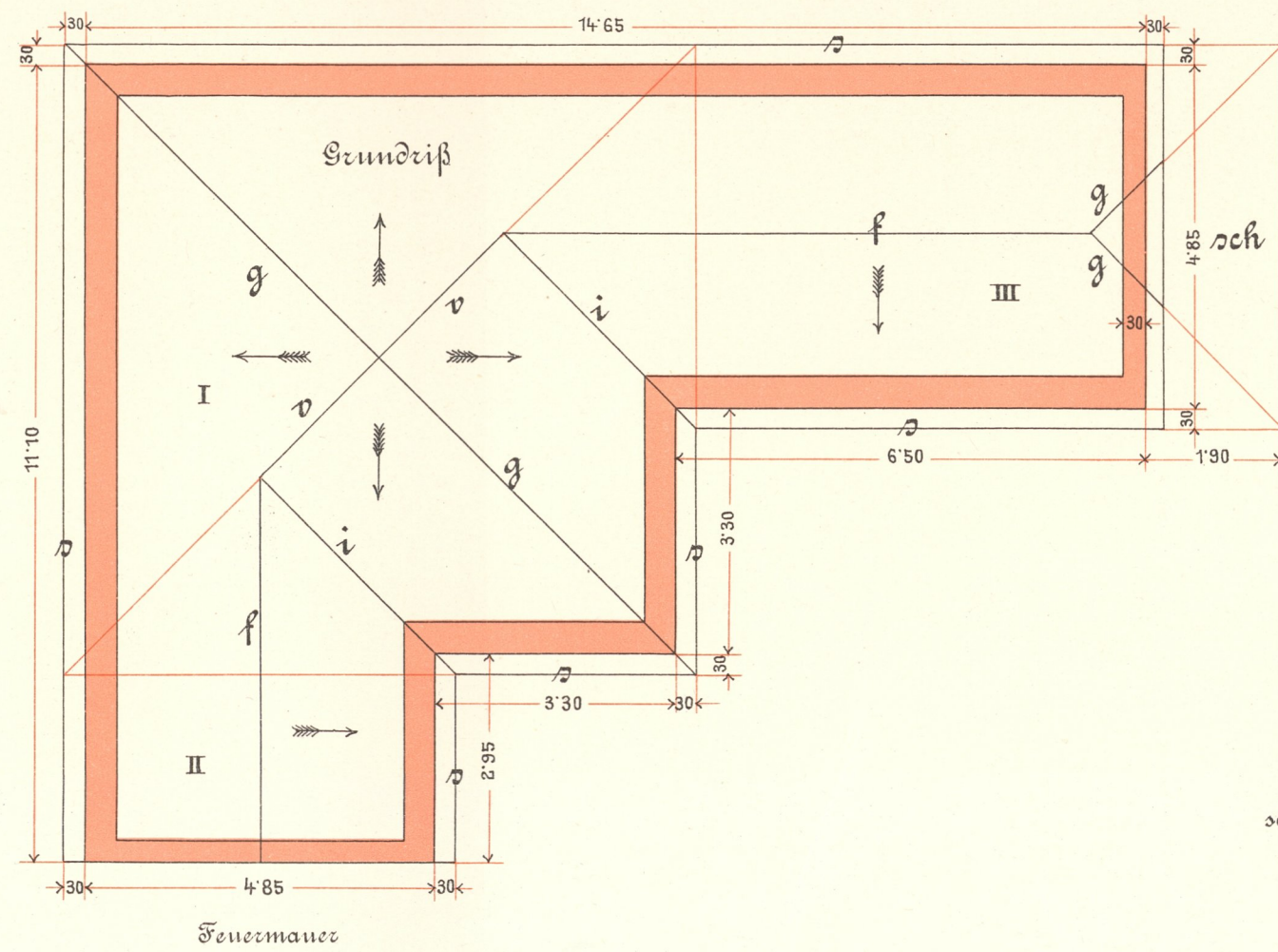

- g = Gratsparren
- i = Ichnsparren
- v = Firstverfallung
- f = Firstlinie
- o = Saumlinie
- sch = Schopf
- w = Walm

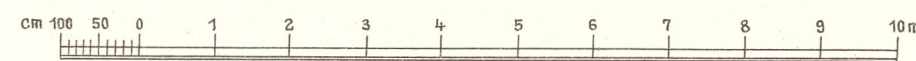
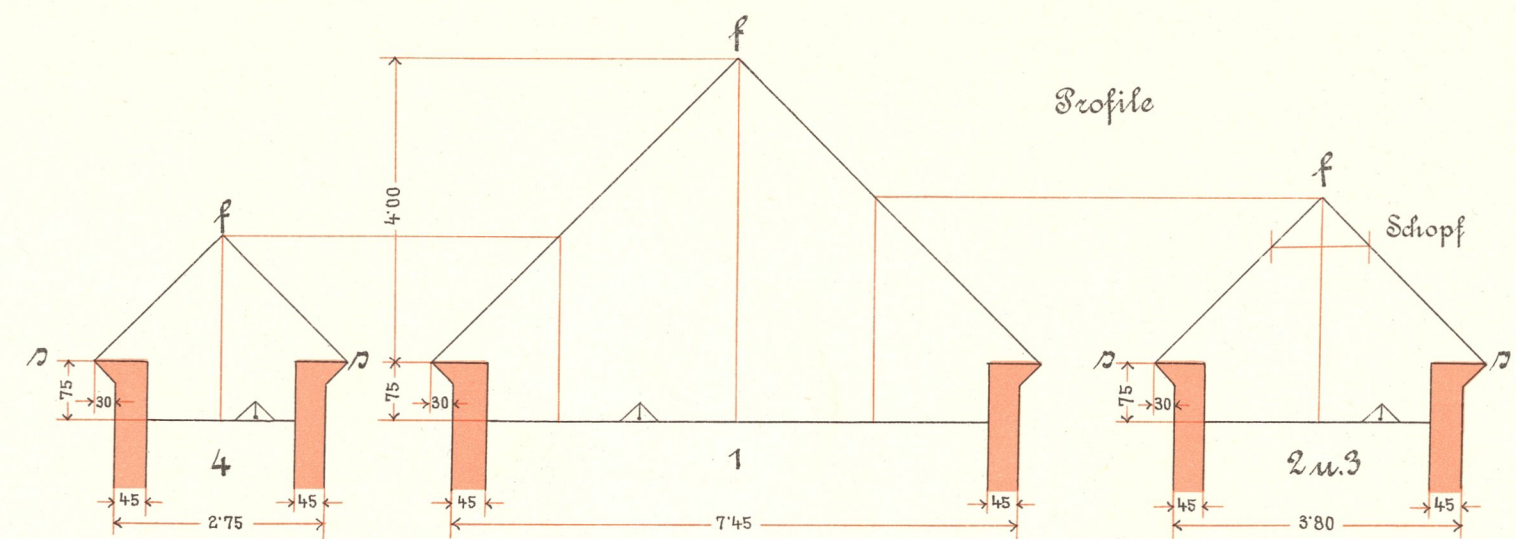
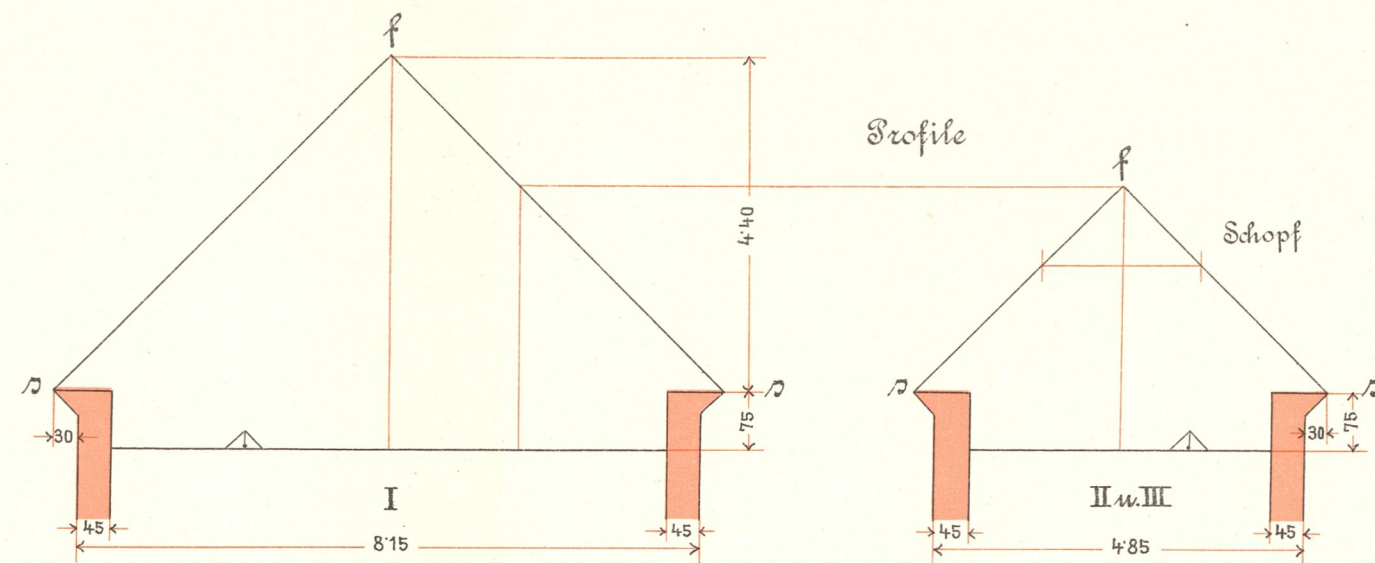
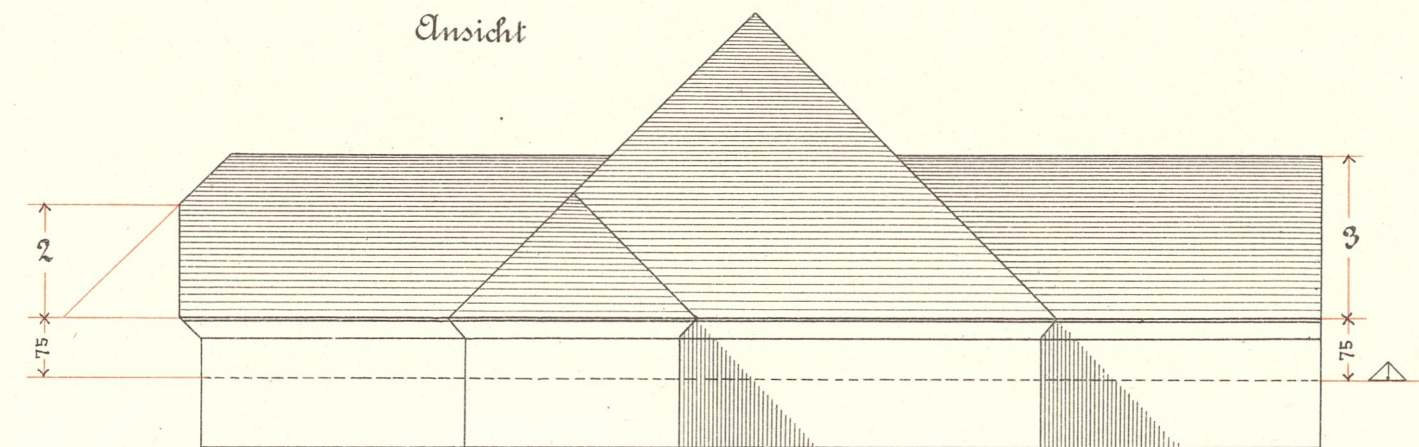
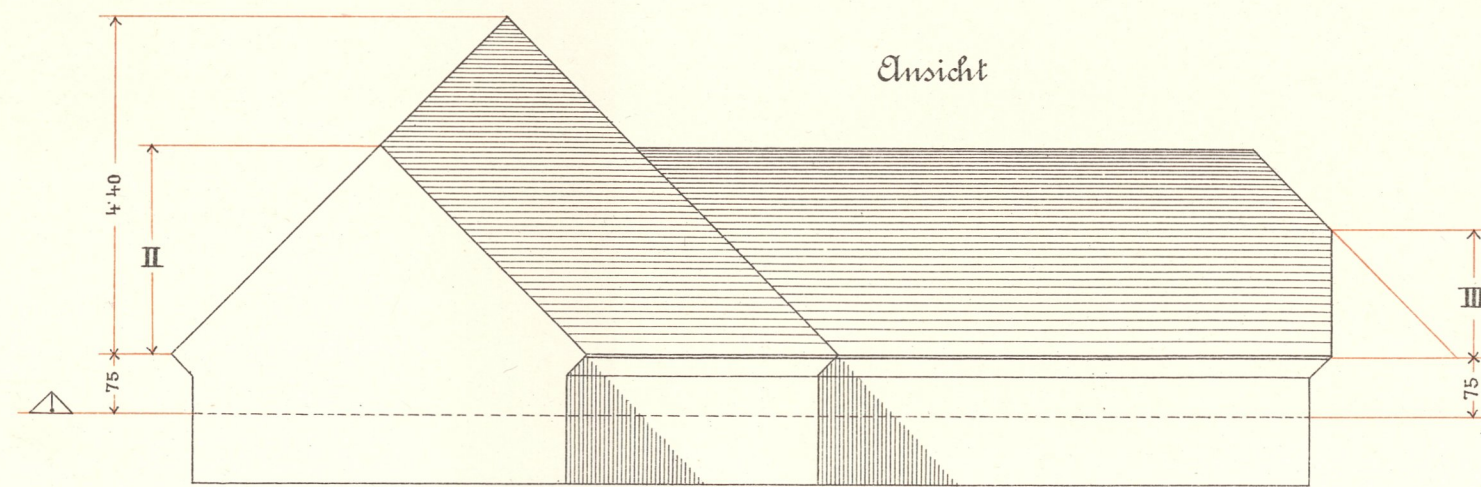

1:100



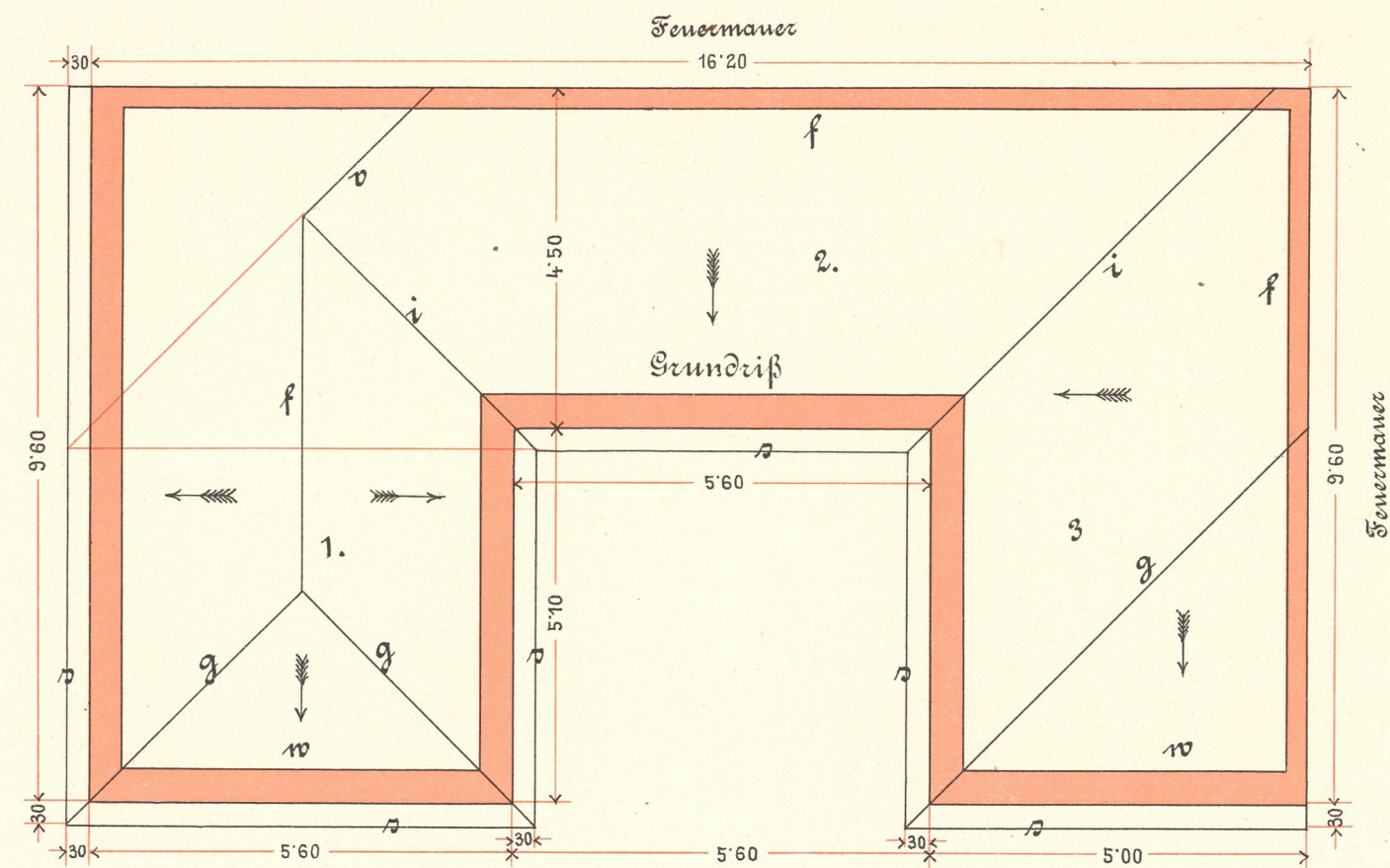
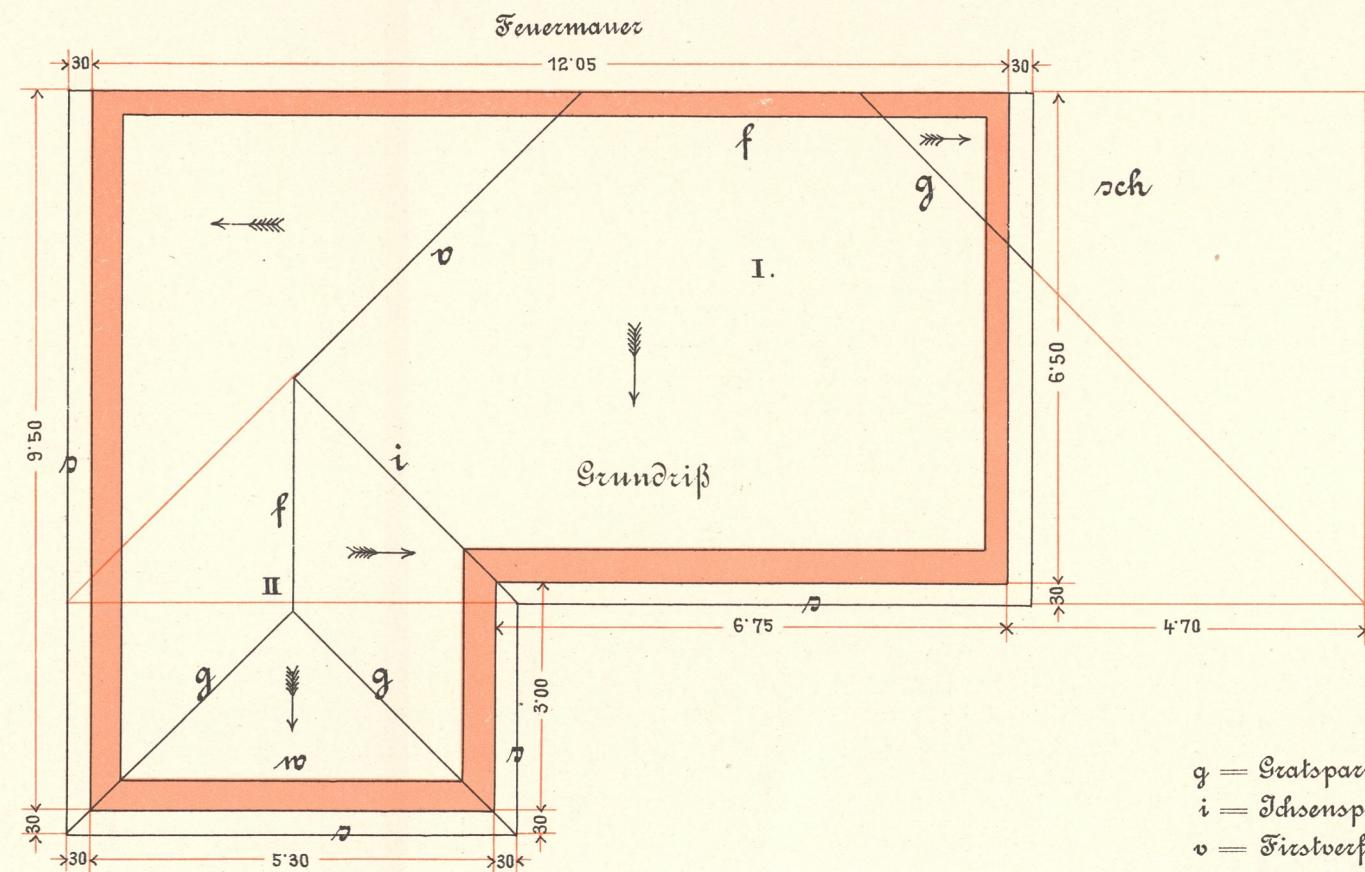

- g = Gratsparren
- i = Ichsensparren
- v = Firstverfallung
- f = Firstlinie
- o = Saumlinie
- sch = Schopf
- w = Walm

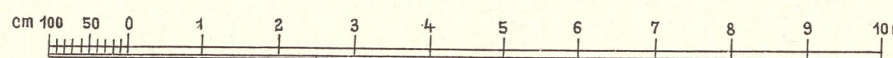
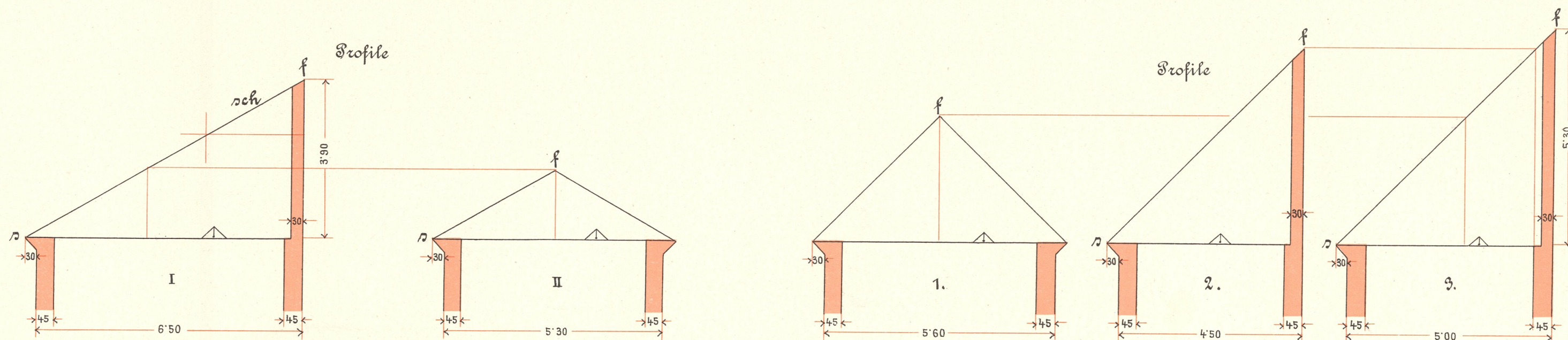
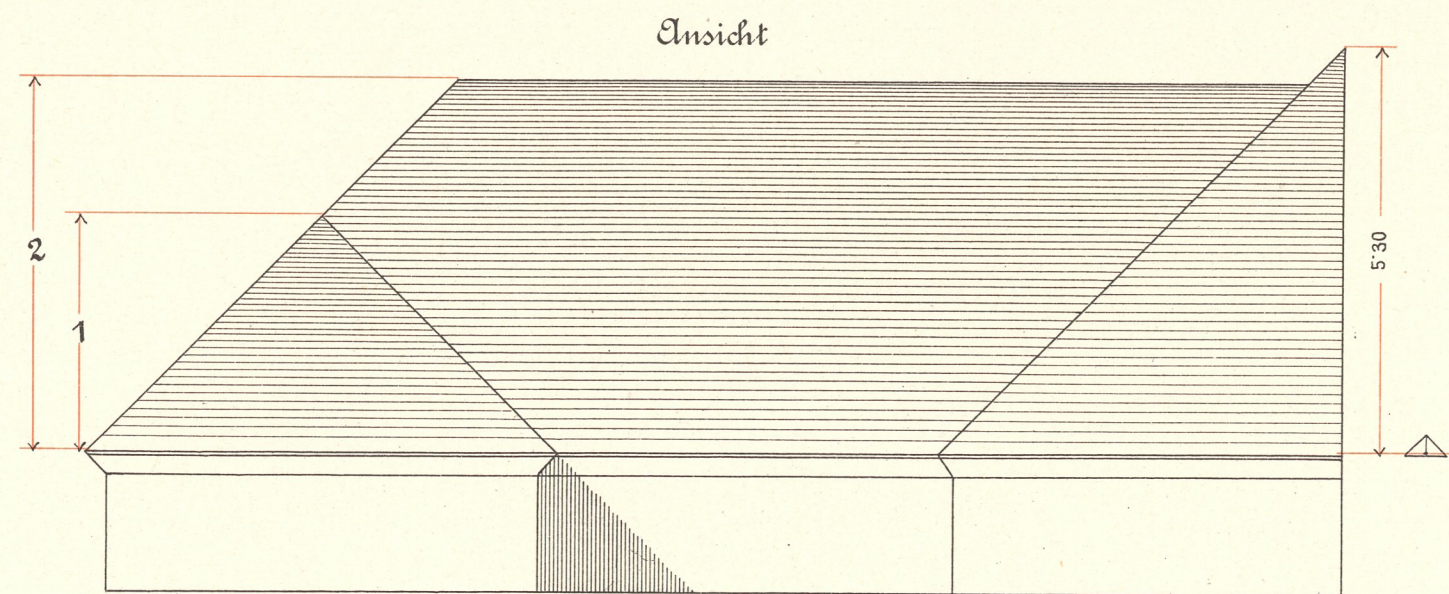
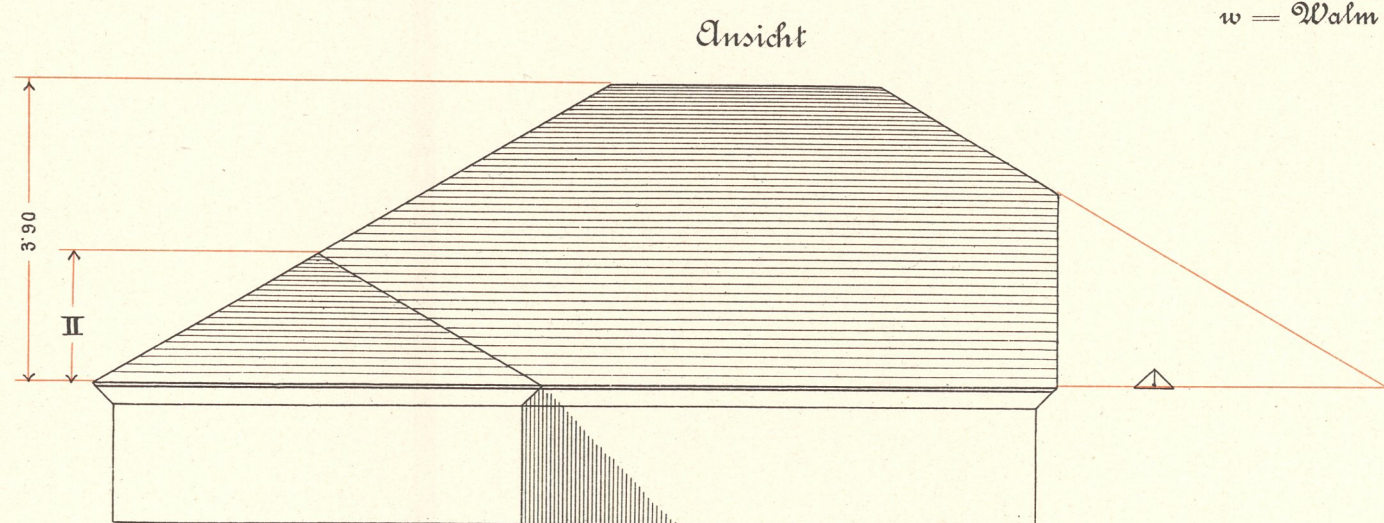

1:100

