

UNIVERSITÄTSBIBLIOTHEK
der Technischen Universität Graz

II RARA-SLG
350337

5084

Atlas

5084

5084

Der

Wagenfabrikant

Theoretisch-praktisches Handbuch

für

alle beim Wagenbau beschäftigten Handwerker
und Gewerbetreibende

Herausgegeben

von

Wilhelm Rausch

vormals in Firma Kopf, Fuchs und Rausch, Wagenfabrik in Halle a. S.

Vierte neu bearbeitete Auflage

Zweiunddreissig Tafeln



Leipzig 1900

Verlag von Bernh. Friedr. Voigt.

Rara-Std.

II
350.337

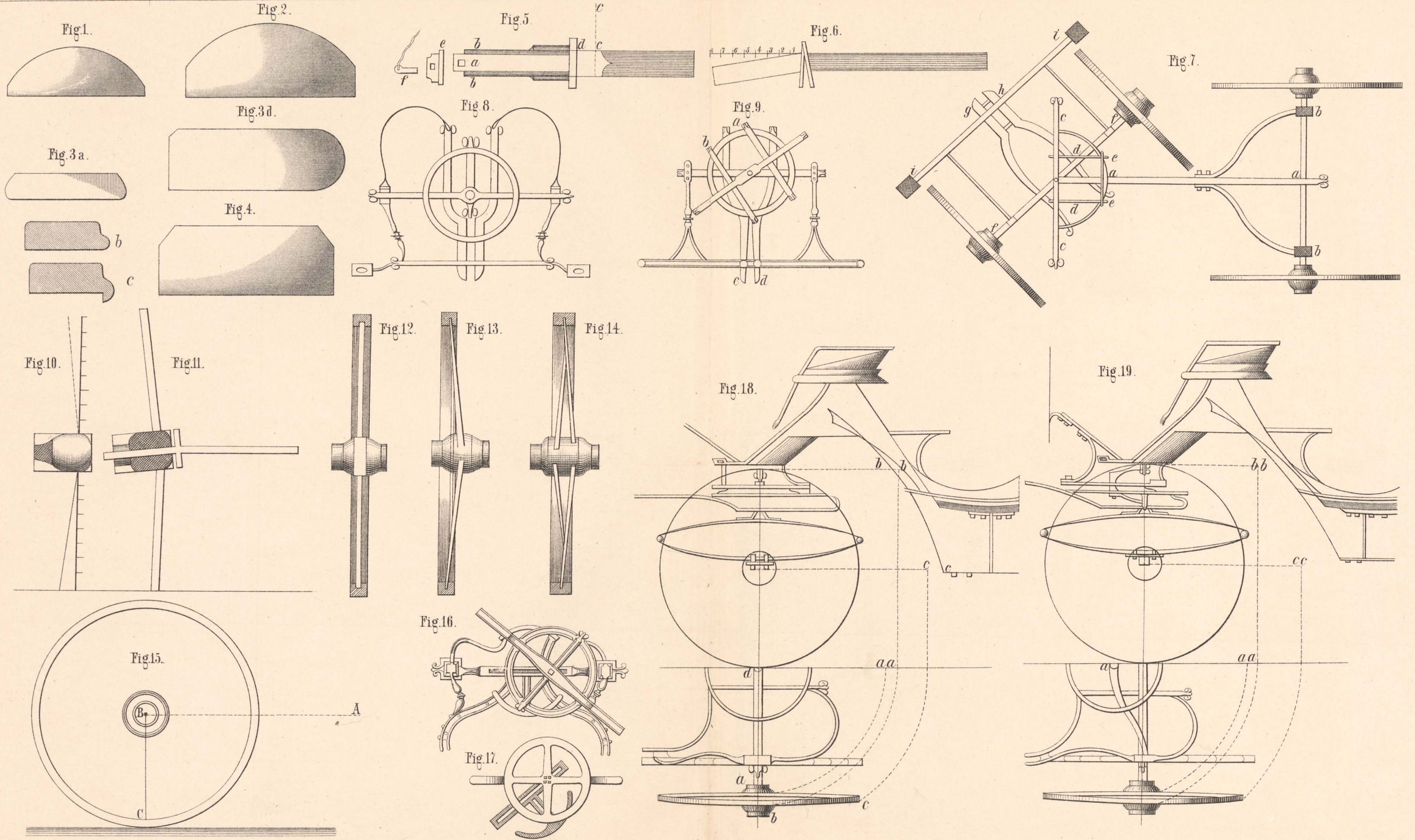
21

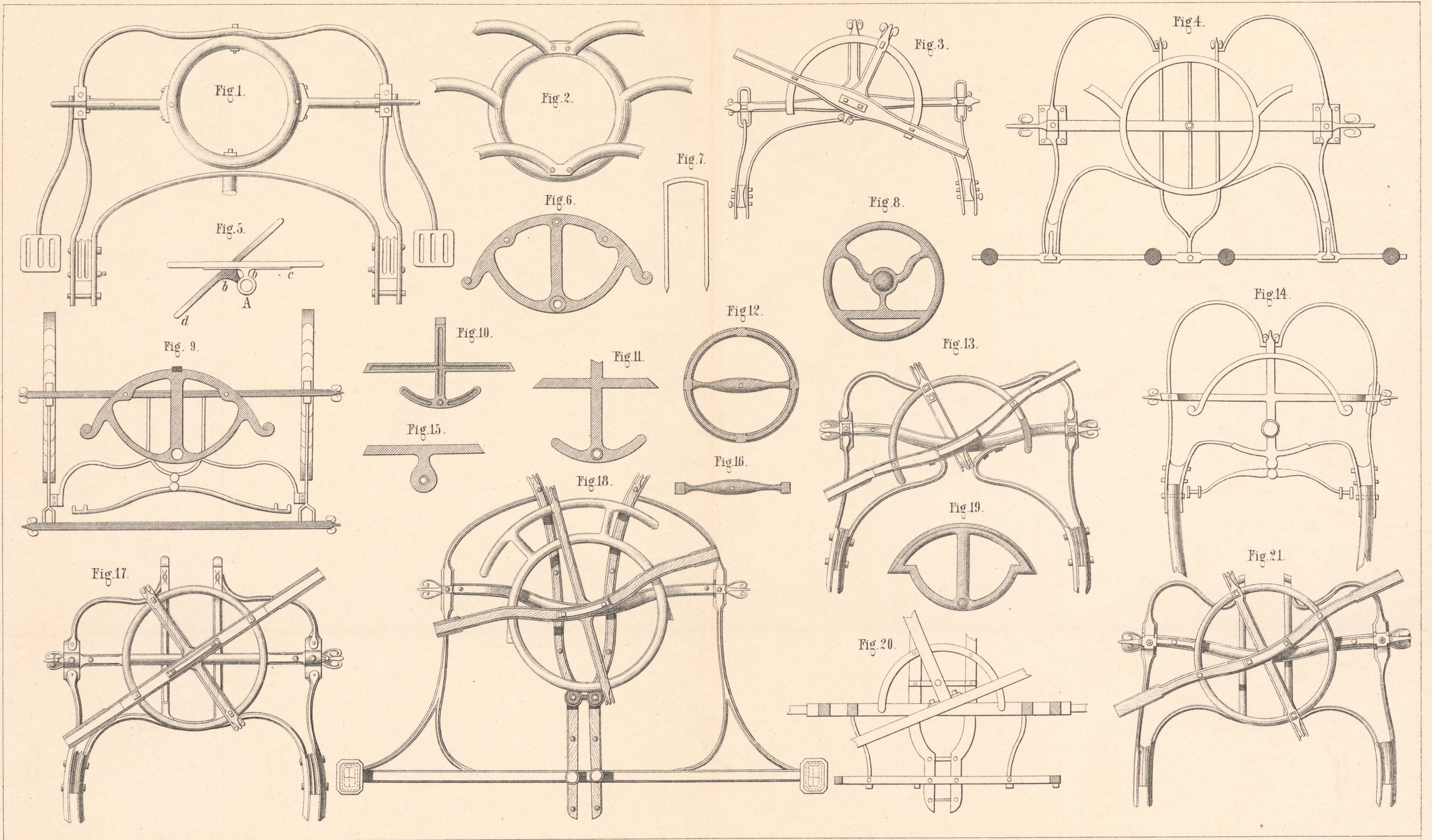
[Faint, illegible text]

Universitätsbibliothek
der Technischen Universität Graz

14. Jan. 1988

869 8035





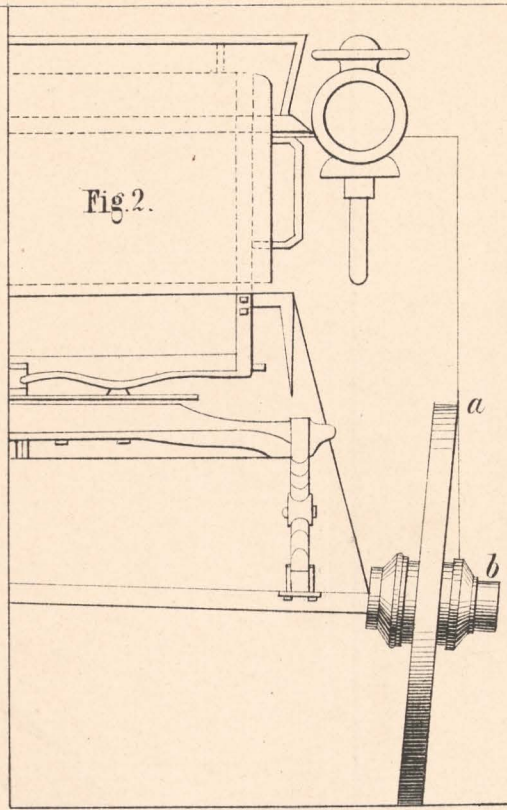


Fig. 2.

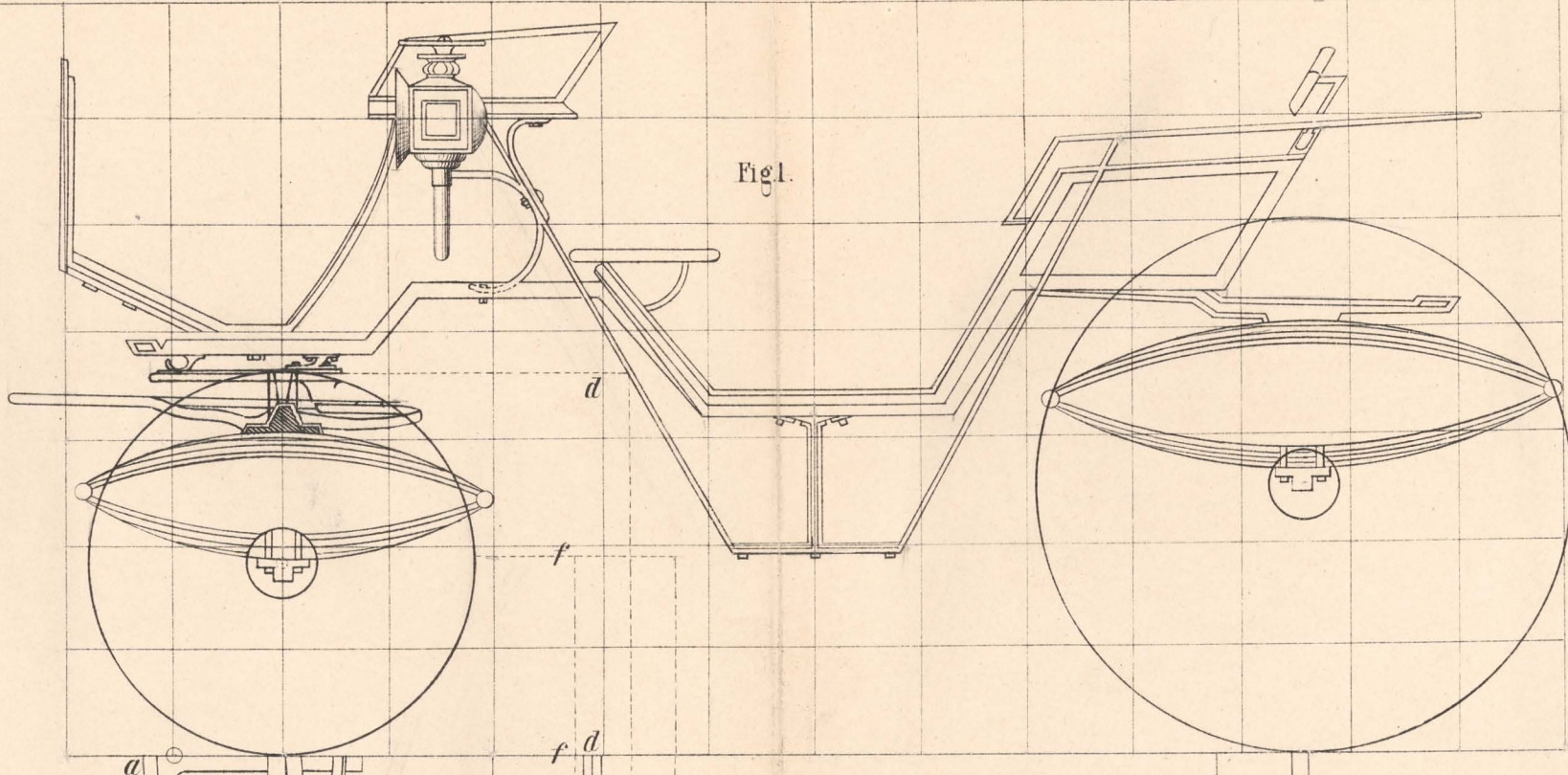


Fig. 1.

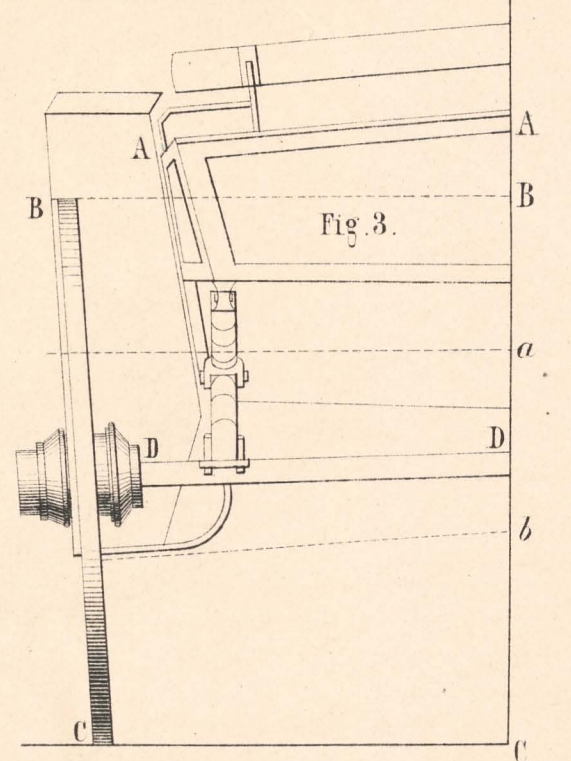


Fig. 3.

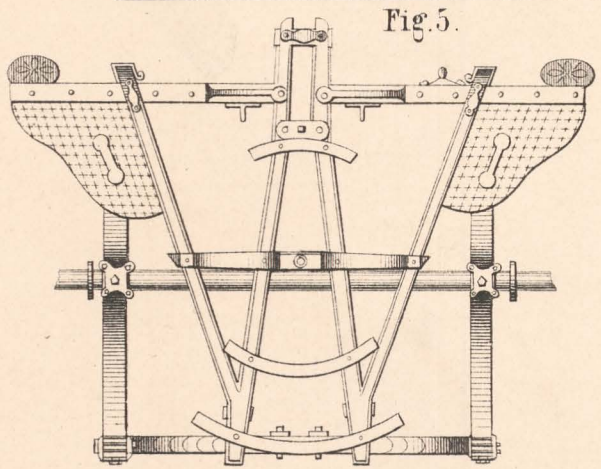


Fig. 5.

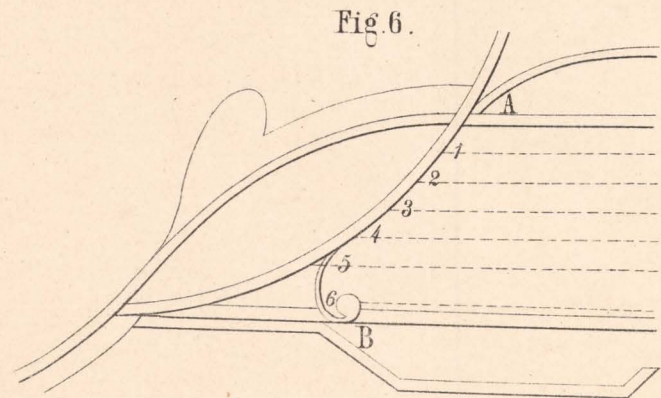
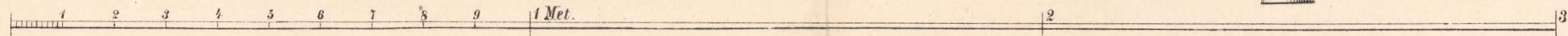
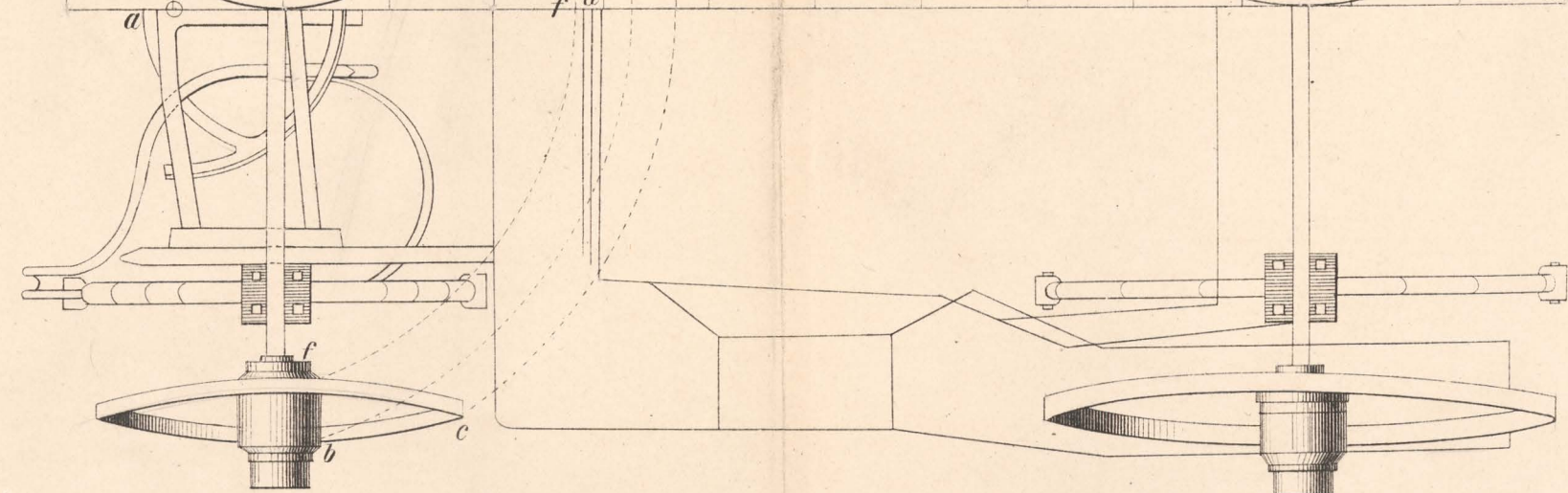


Fig. 6.

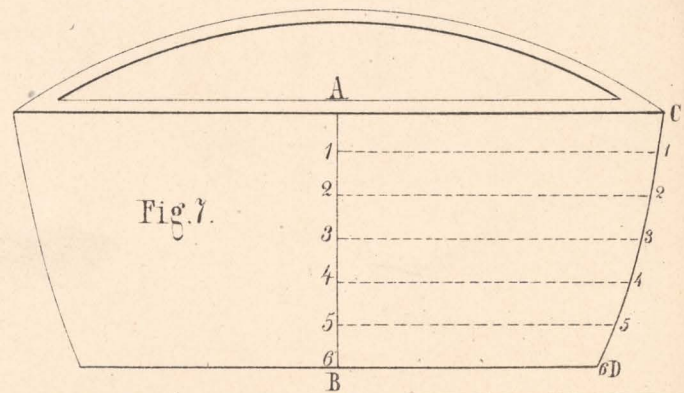


Fig. 7.

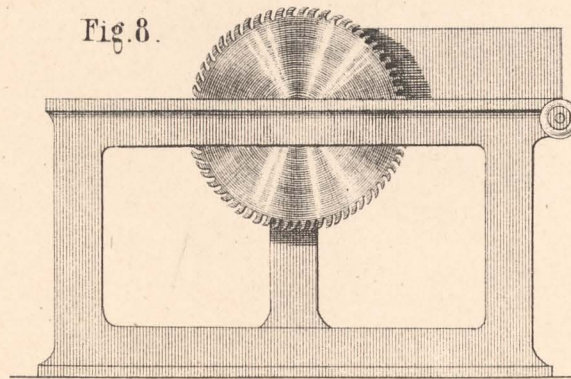


Fig. 8.

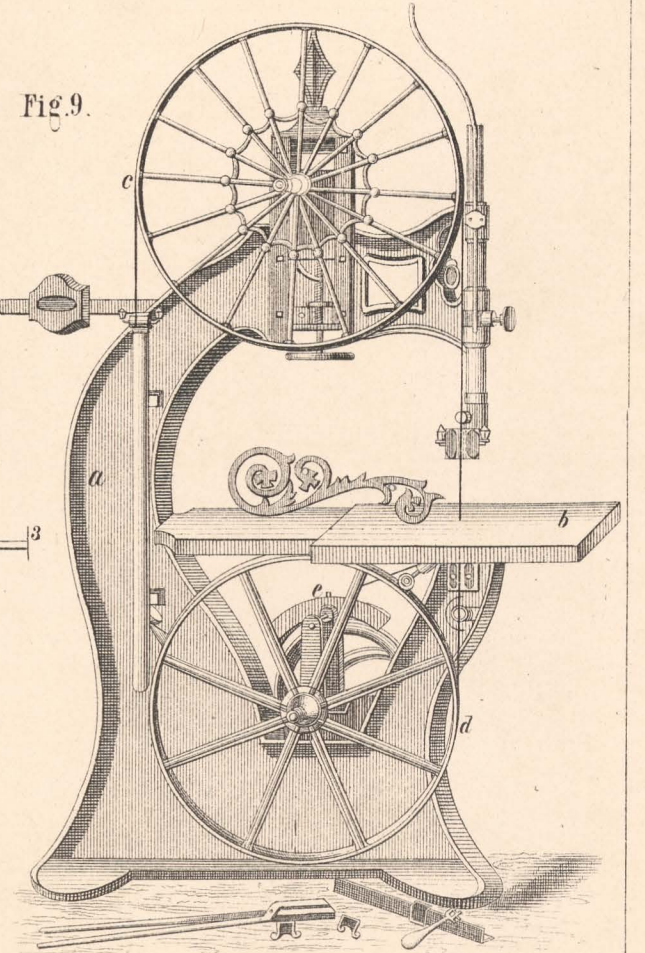


Fig. 9.

2 Meter.

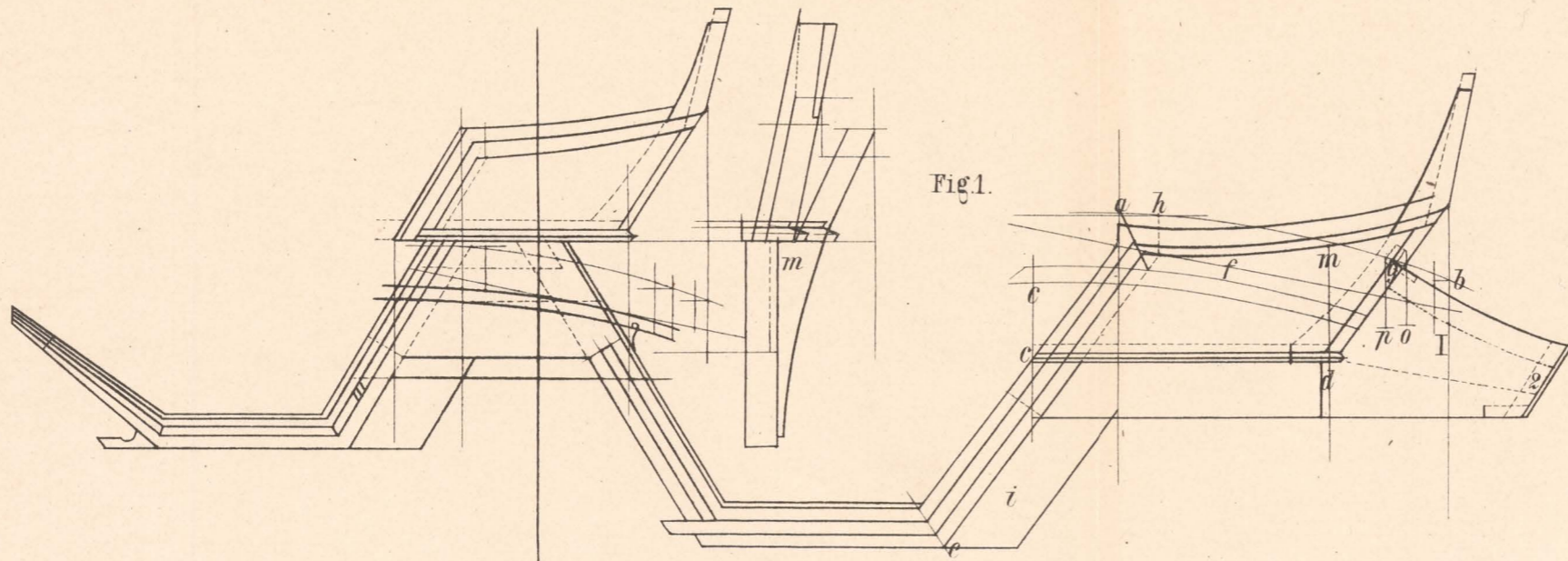


Fig.1.

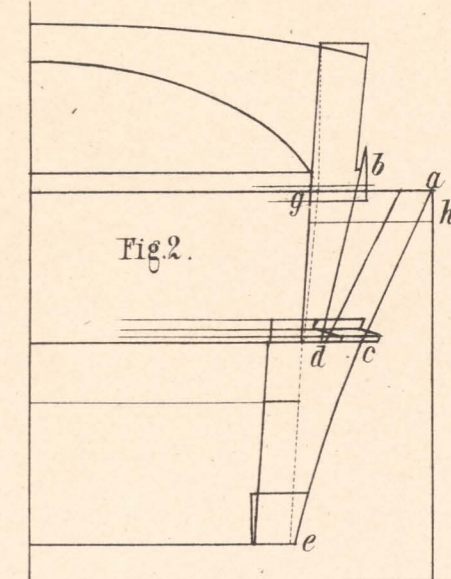


Fig.2.

1 Meter.

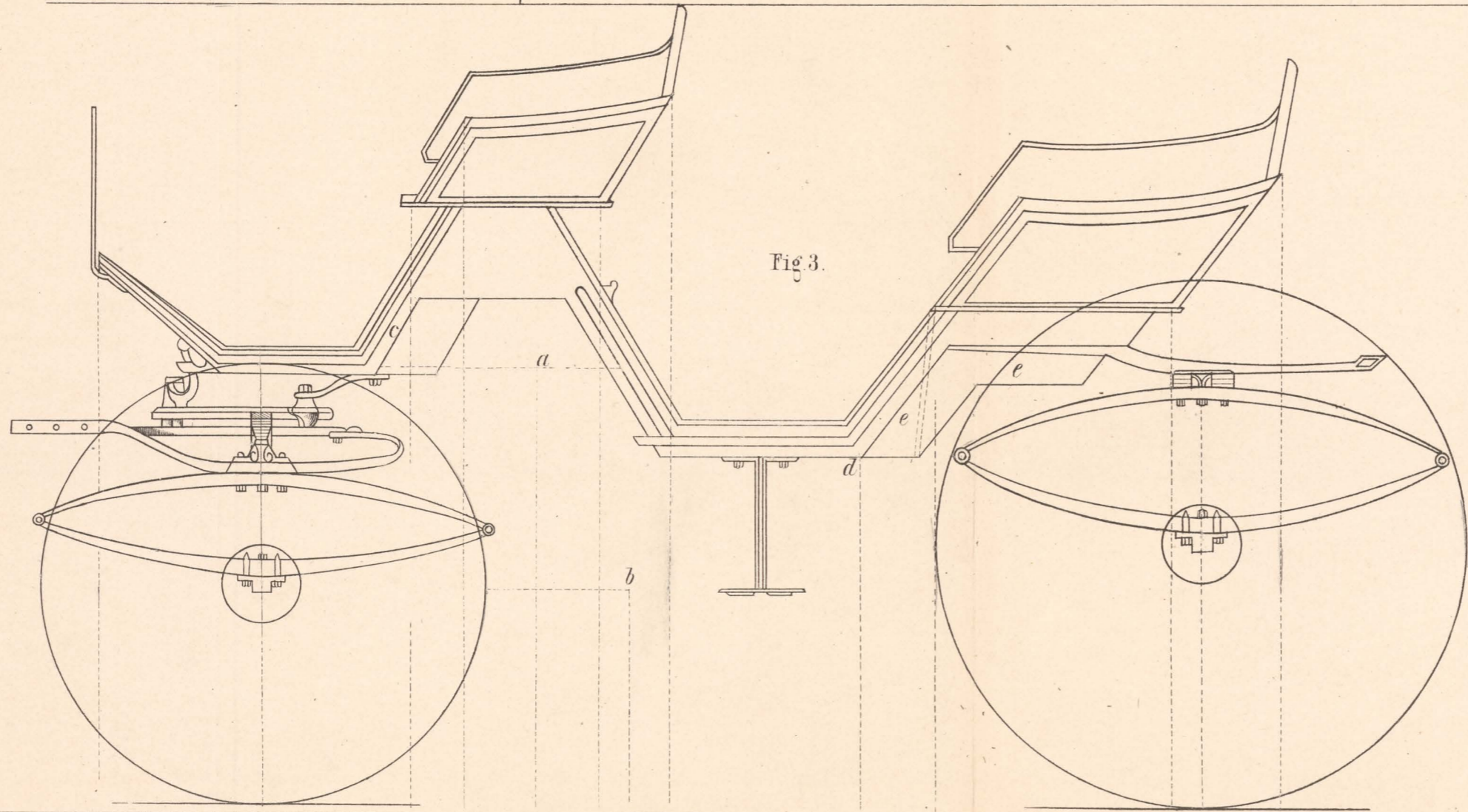


Fig.3.

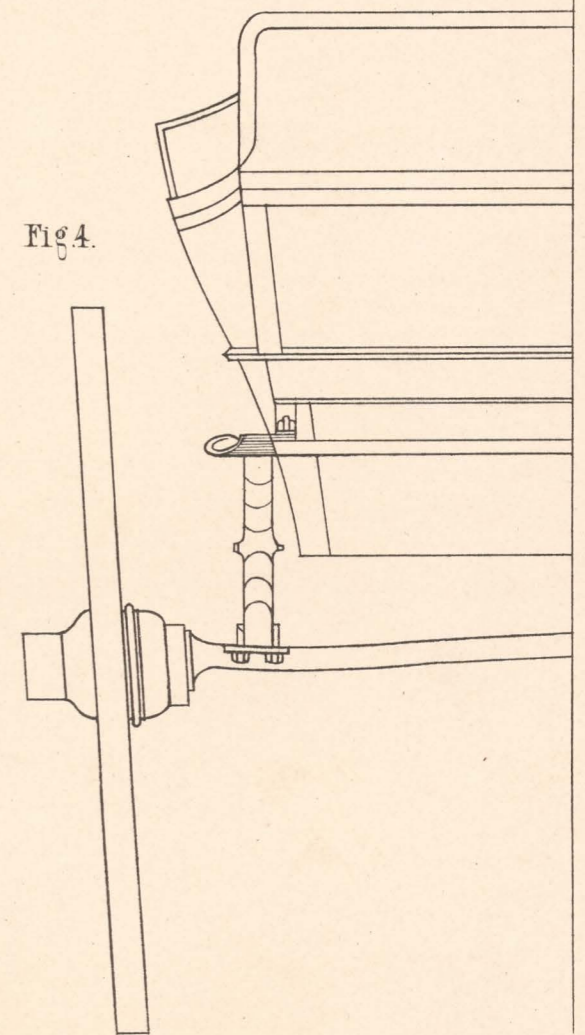
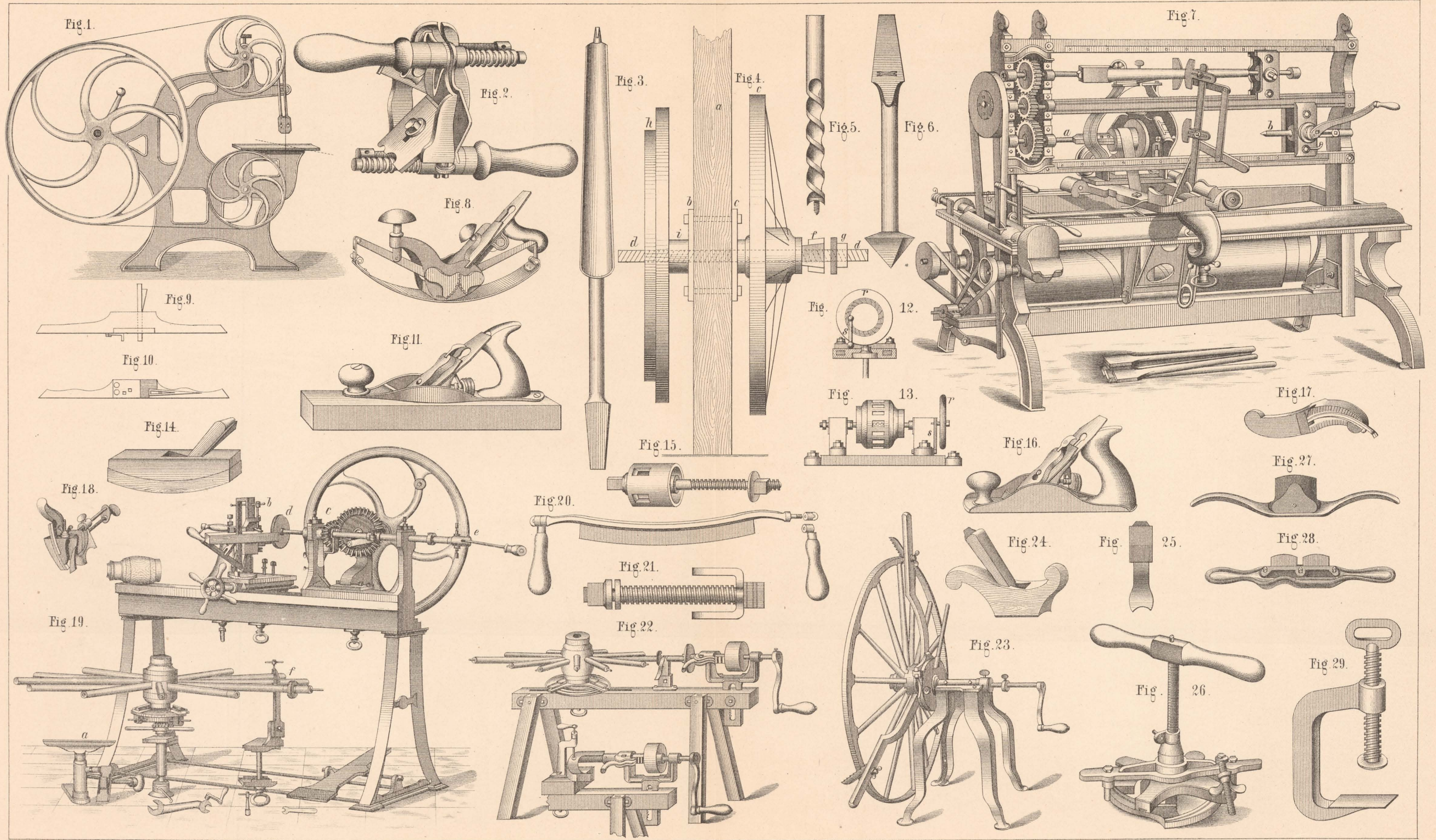
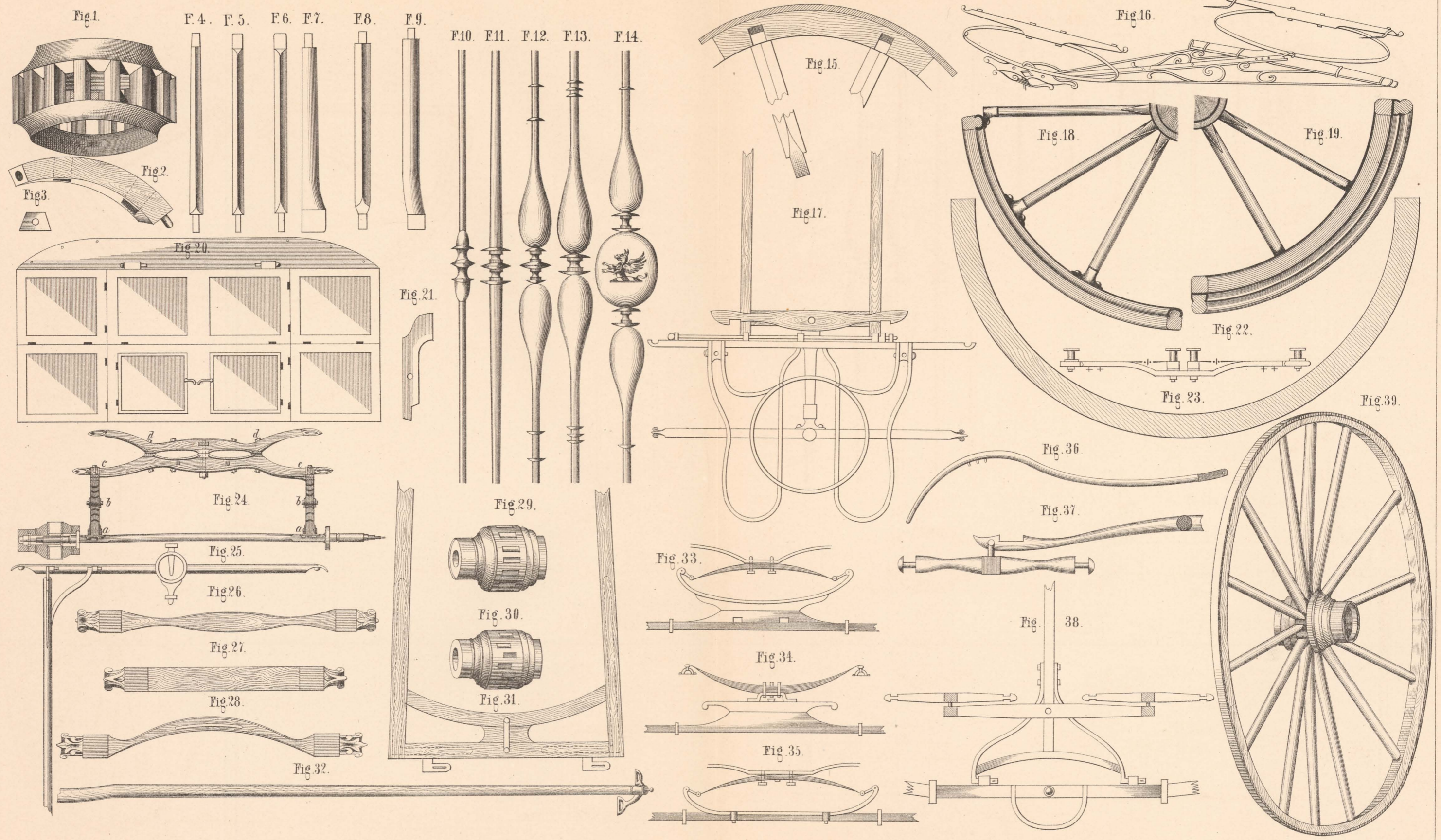
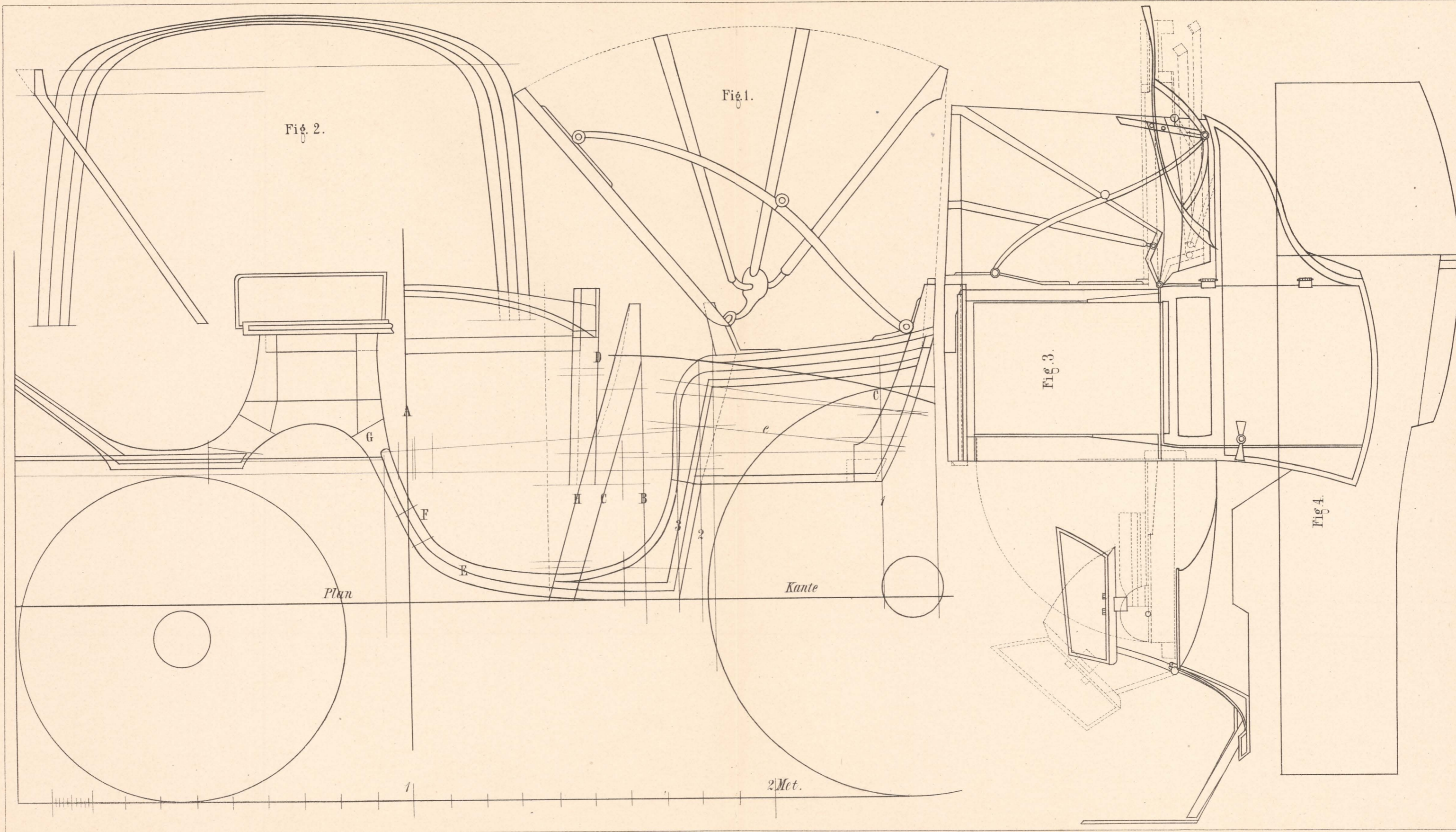
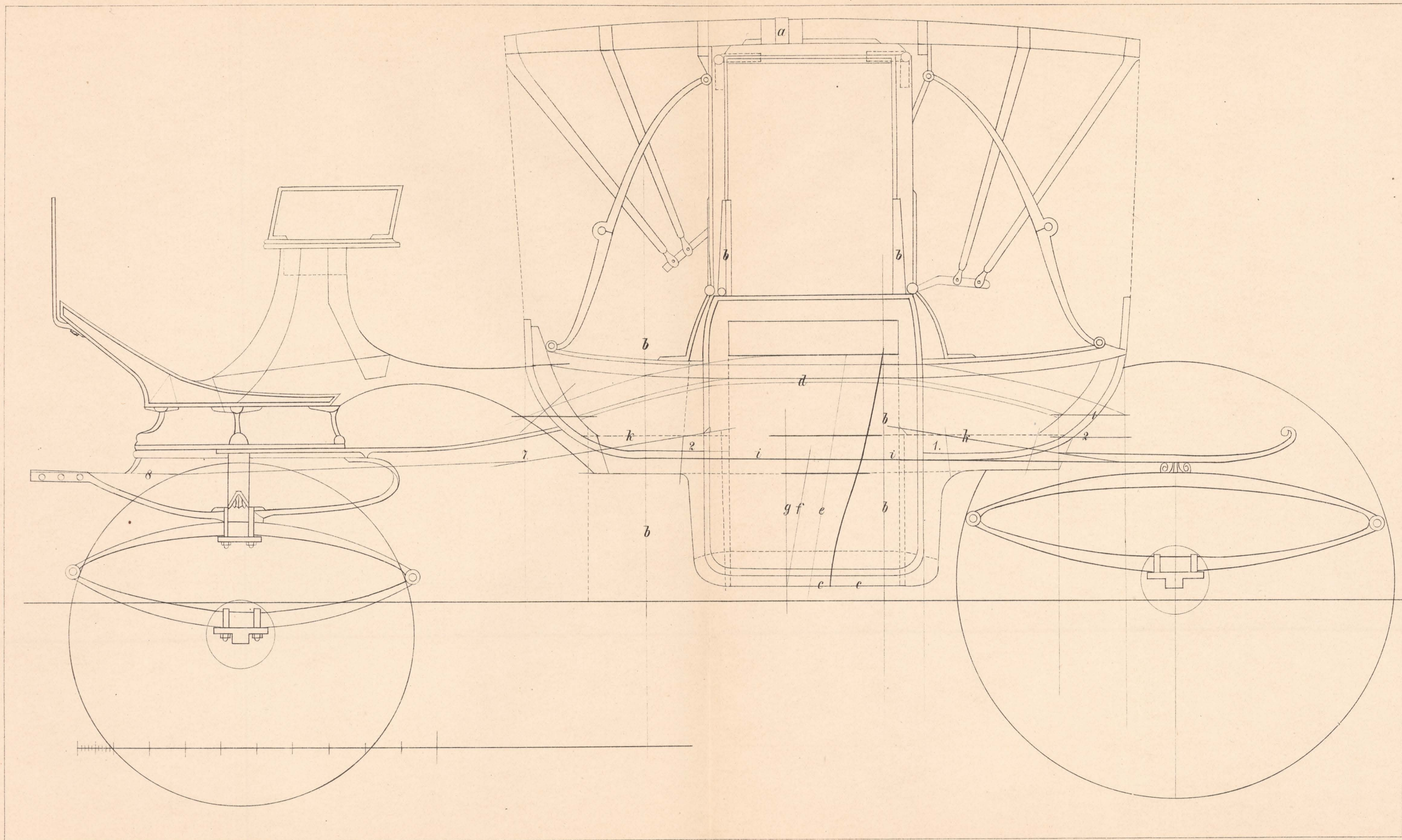


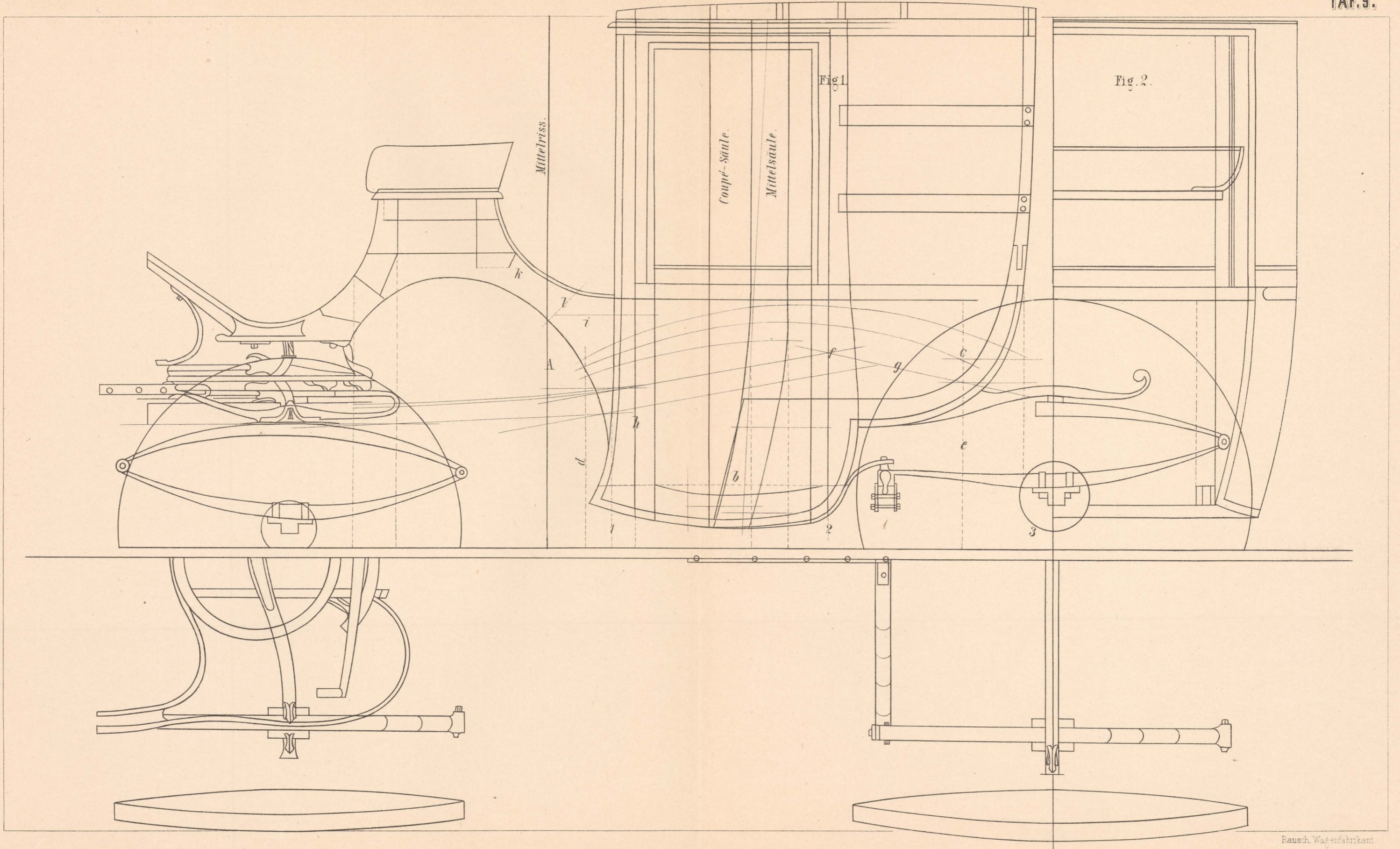
Fig.4.

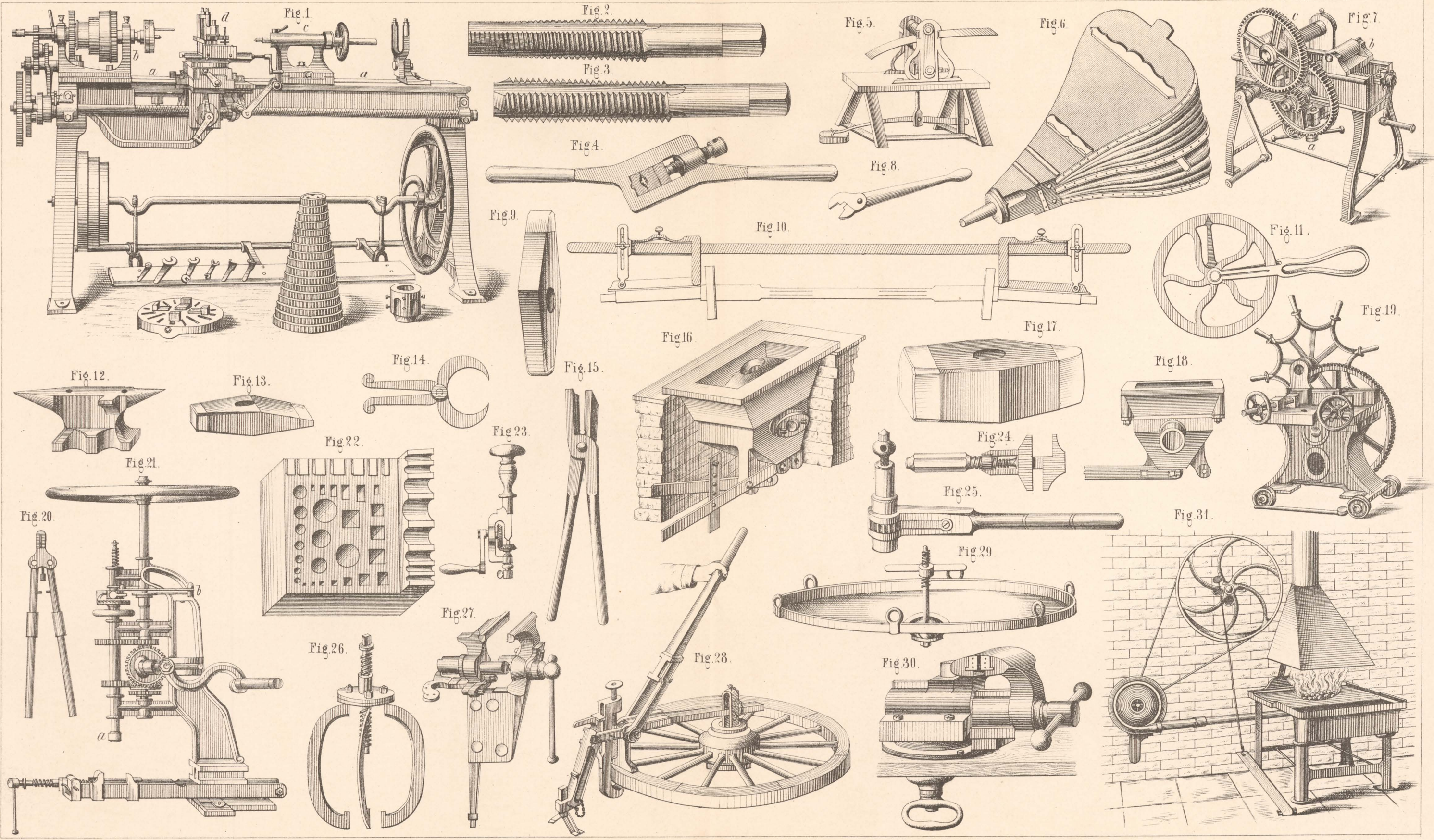


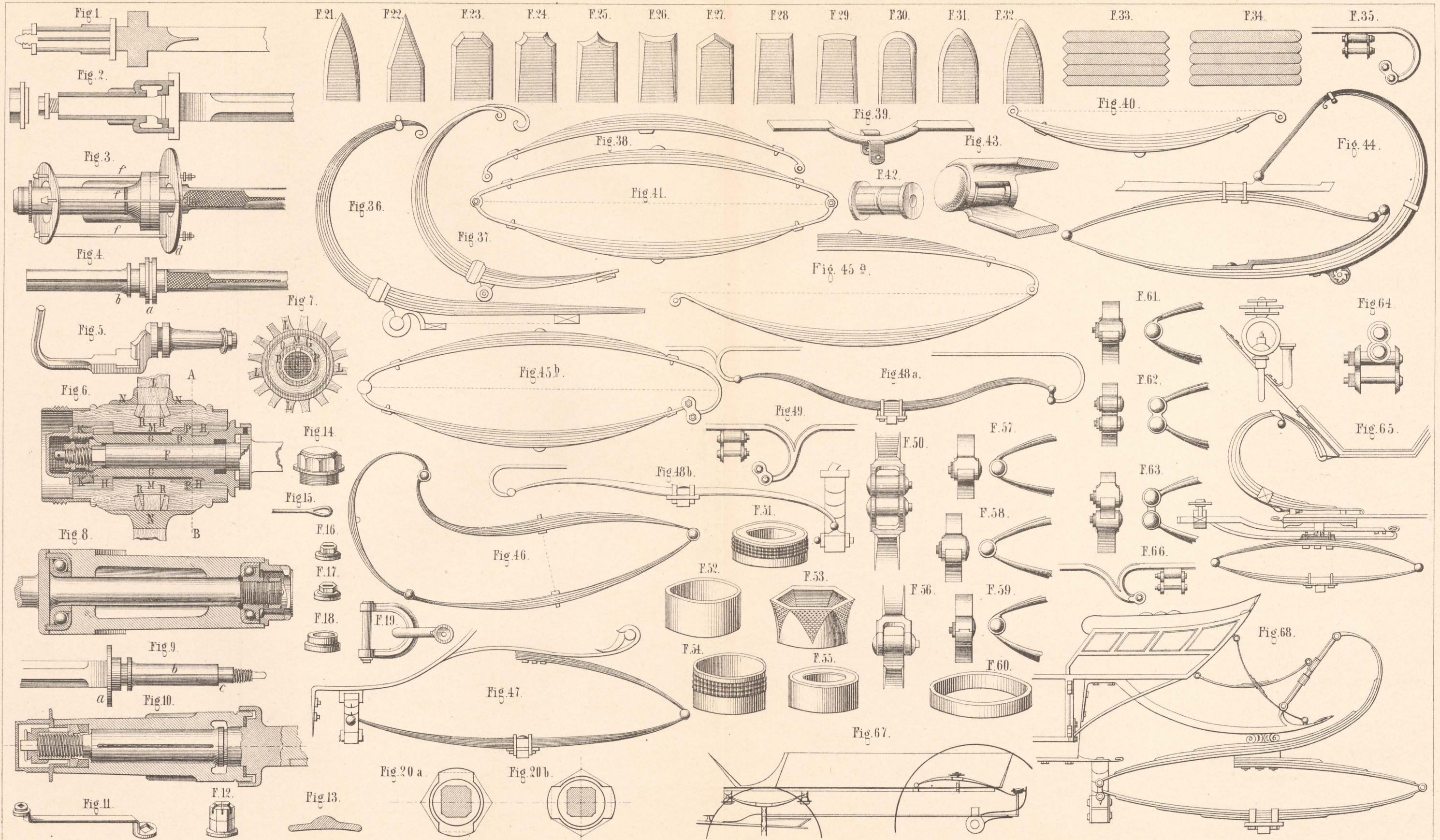


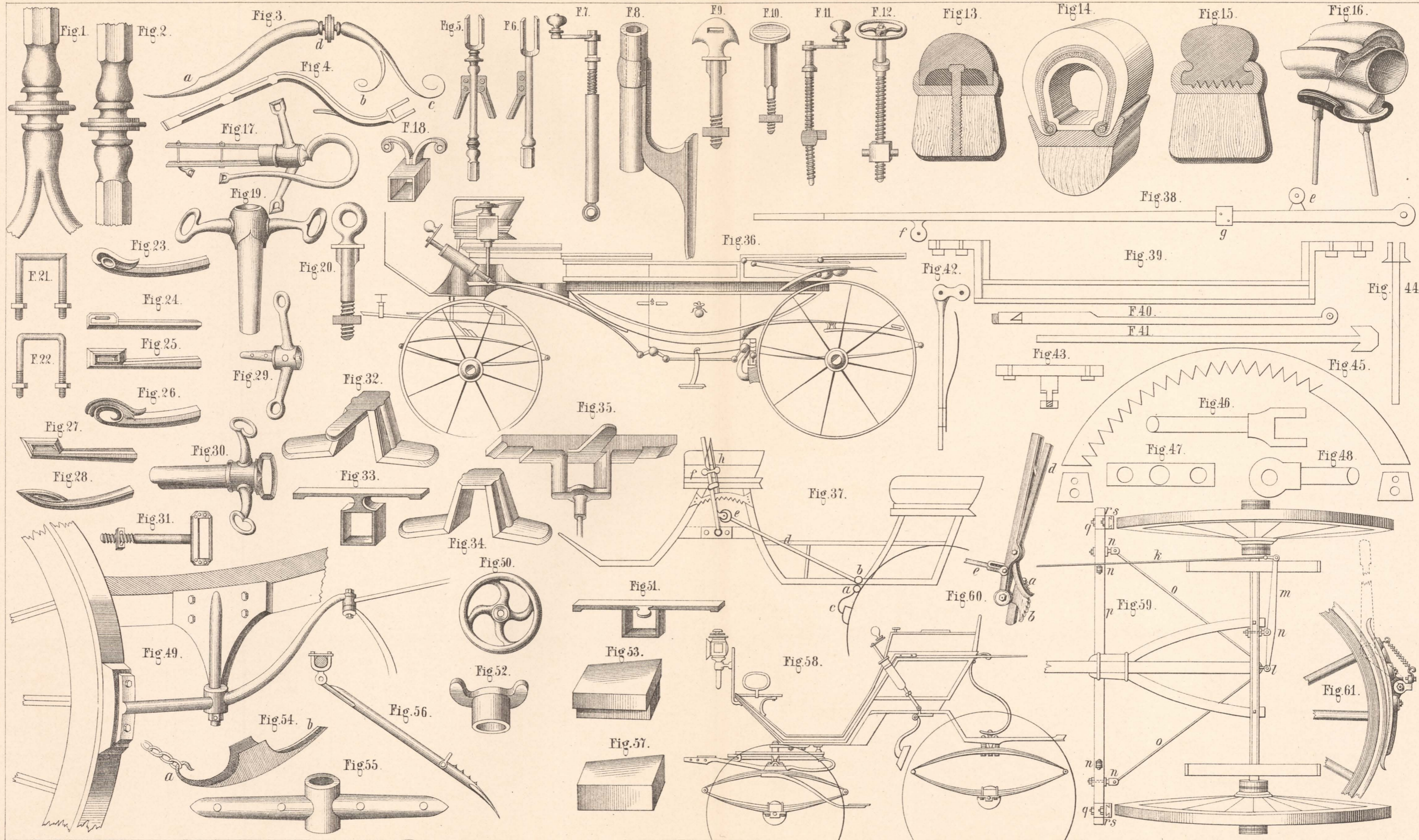


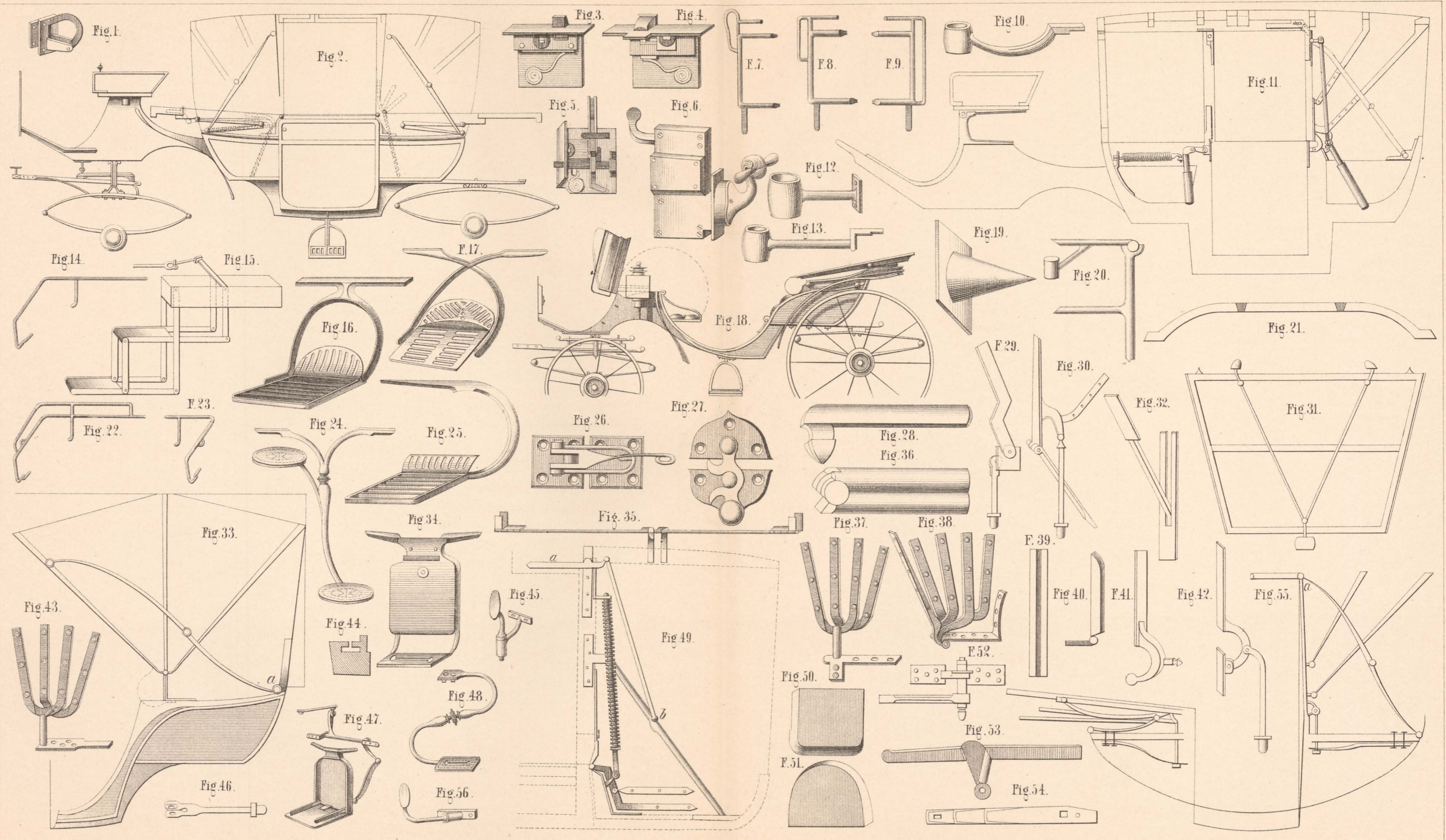


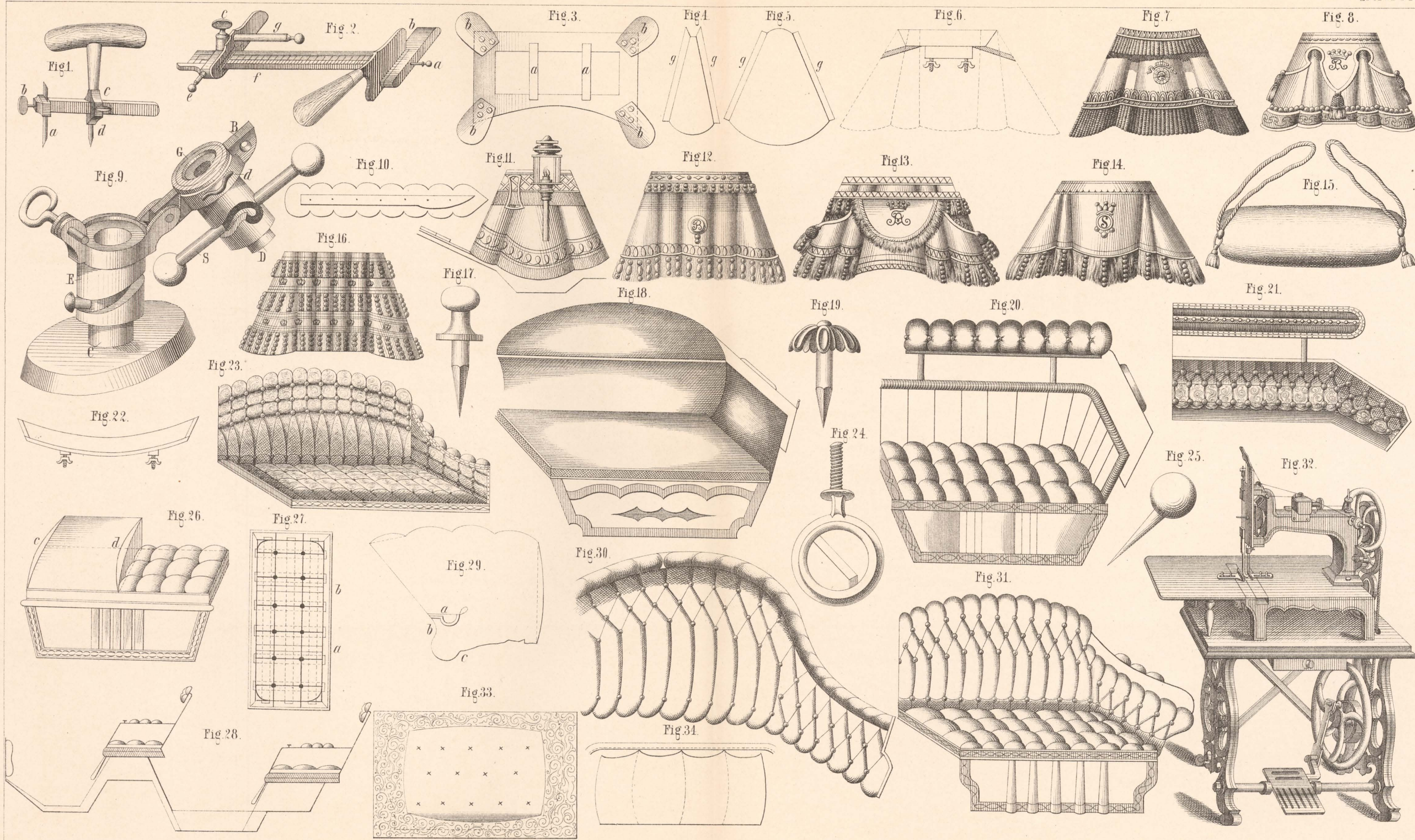


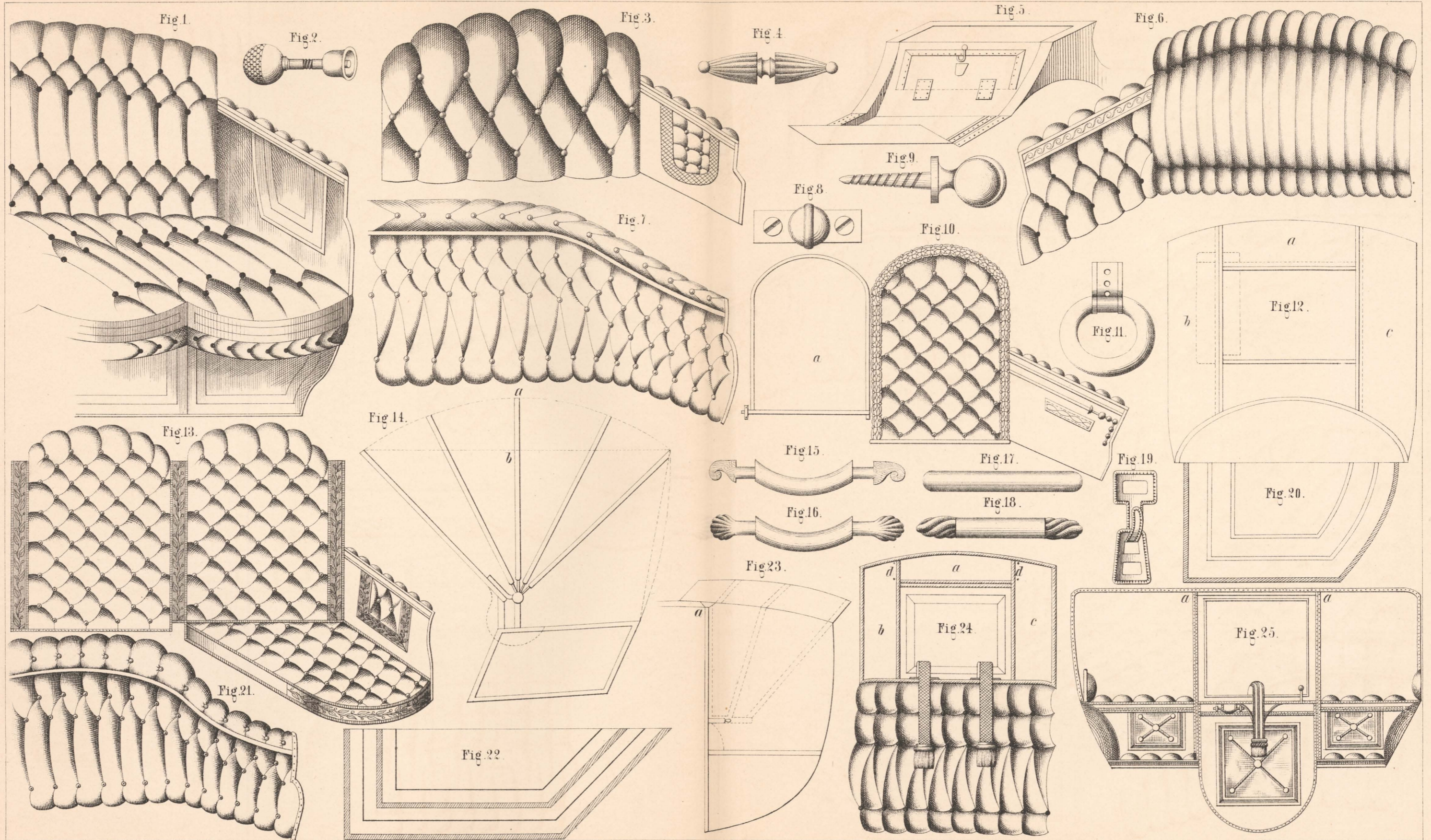


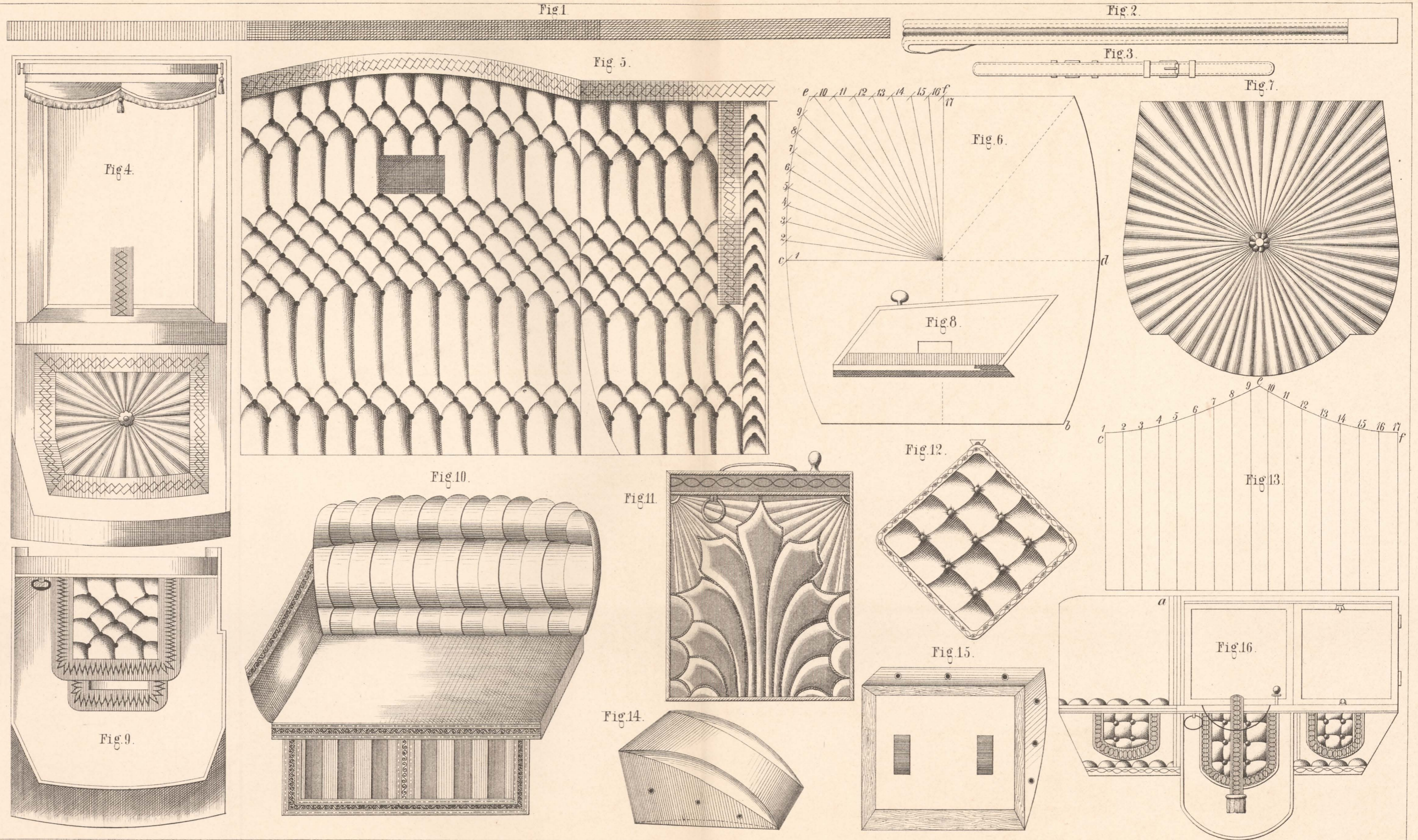


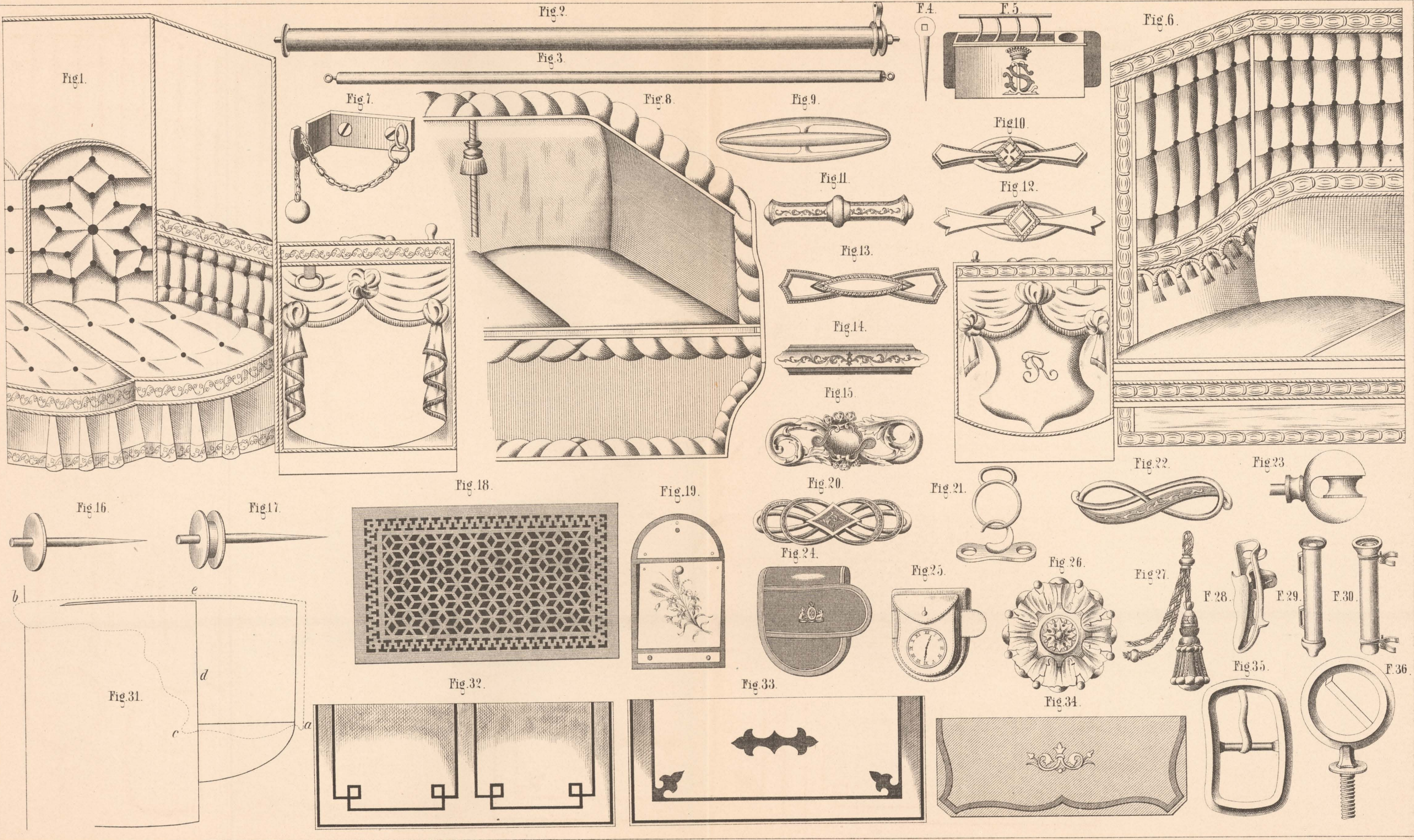












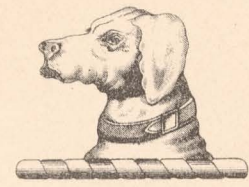
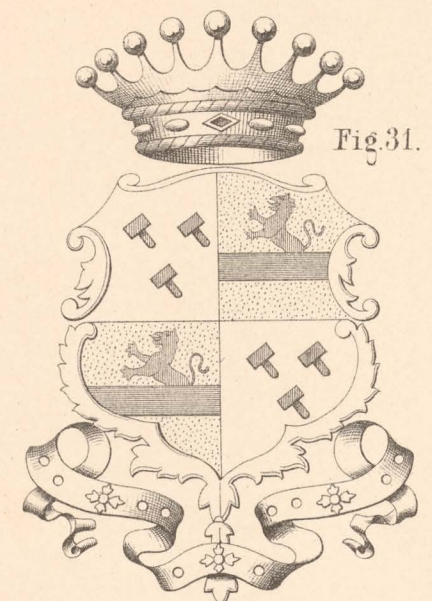
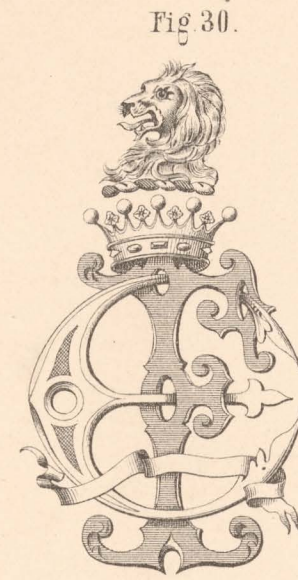
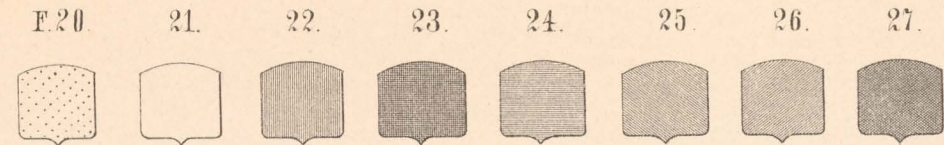
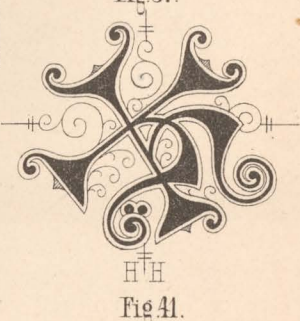
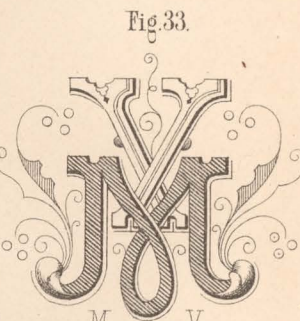
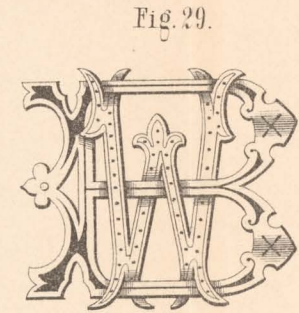
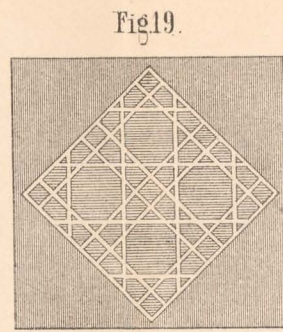
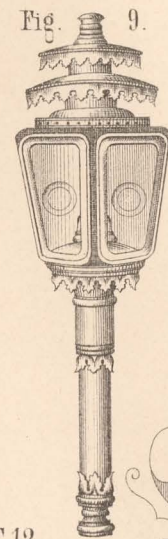
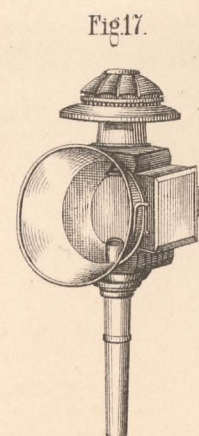
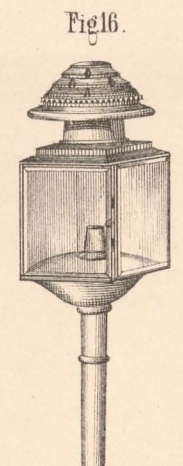
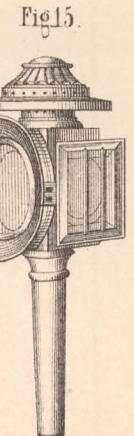
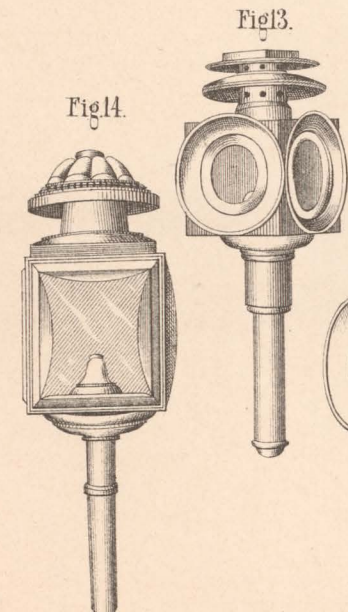
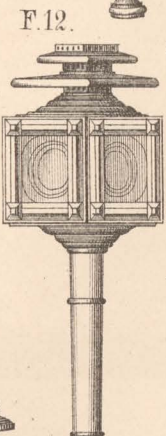
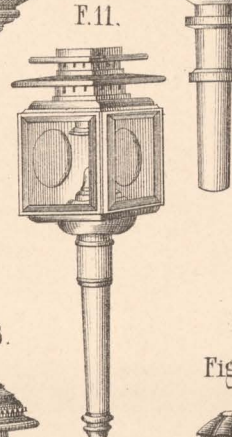
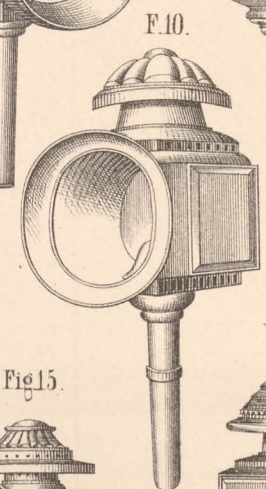
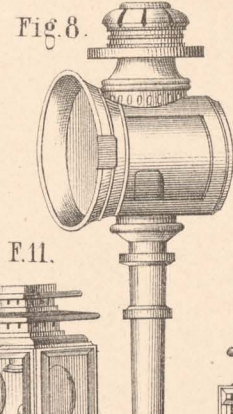
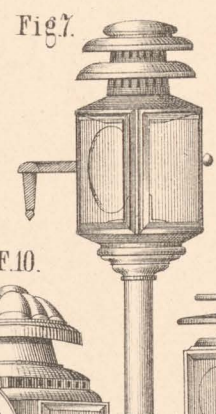
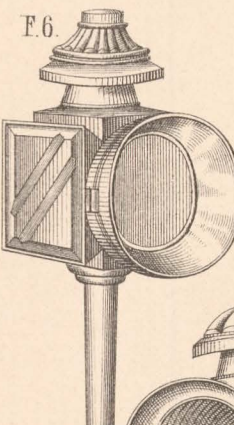
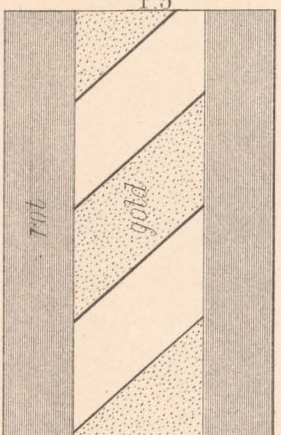
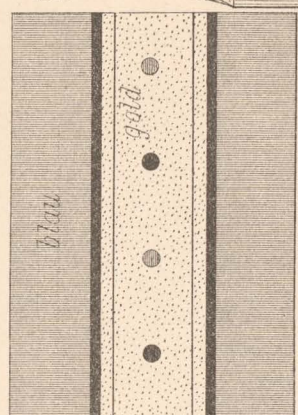
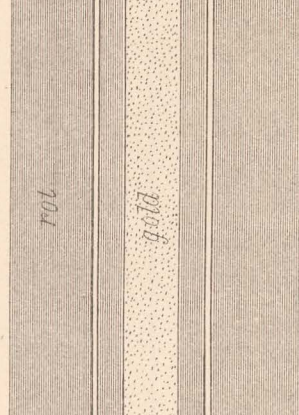
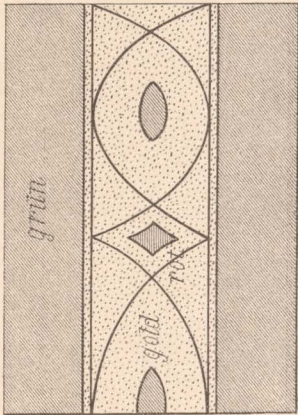
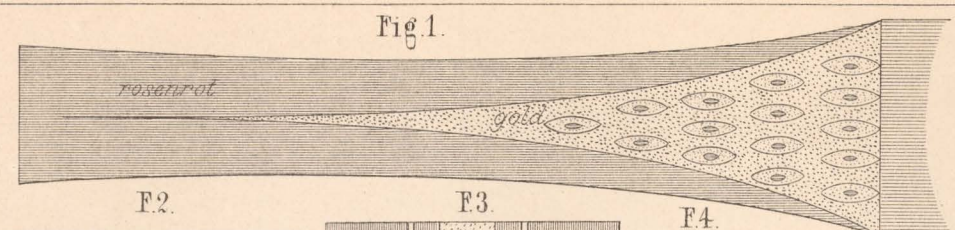
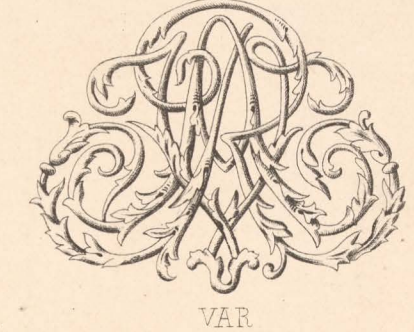
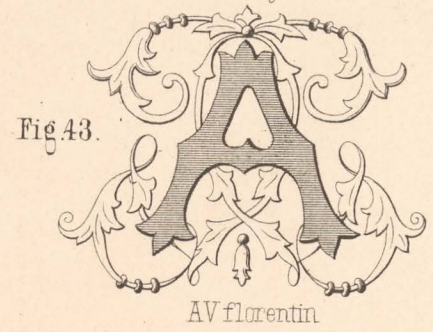
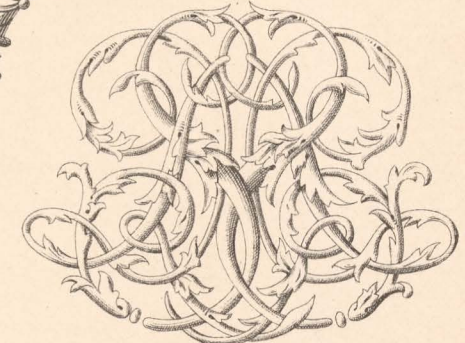
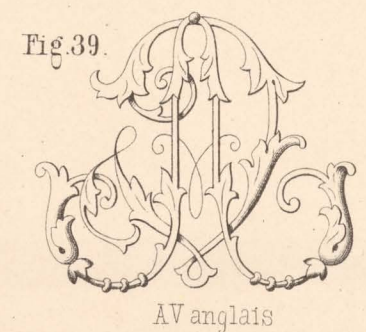
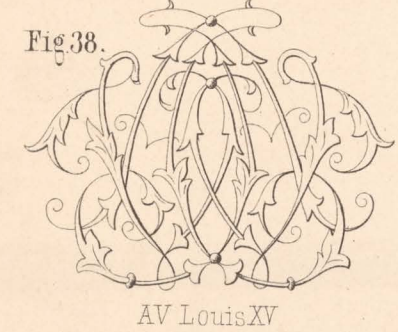
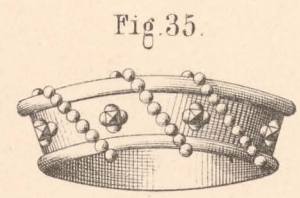
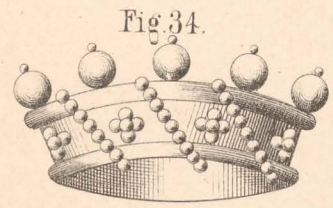


Fig. 32.



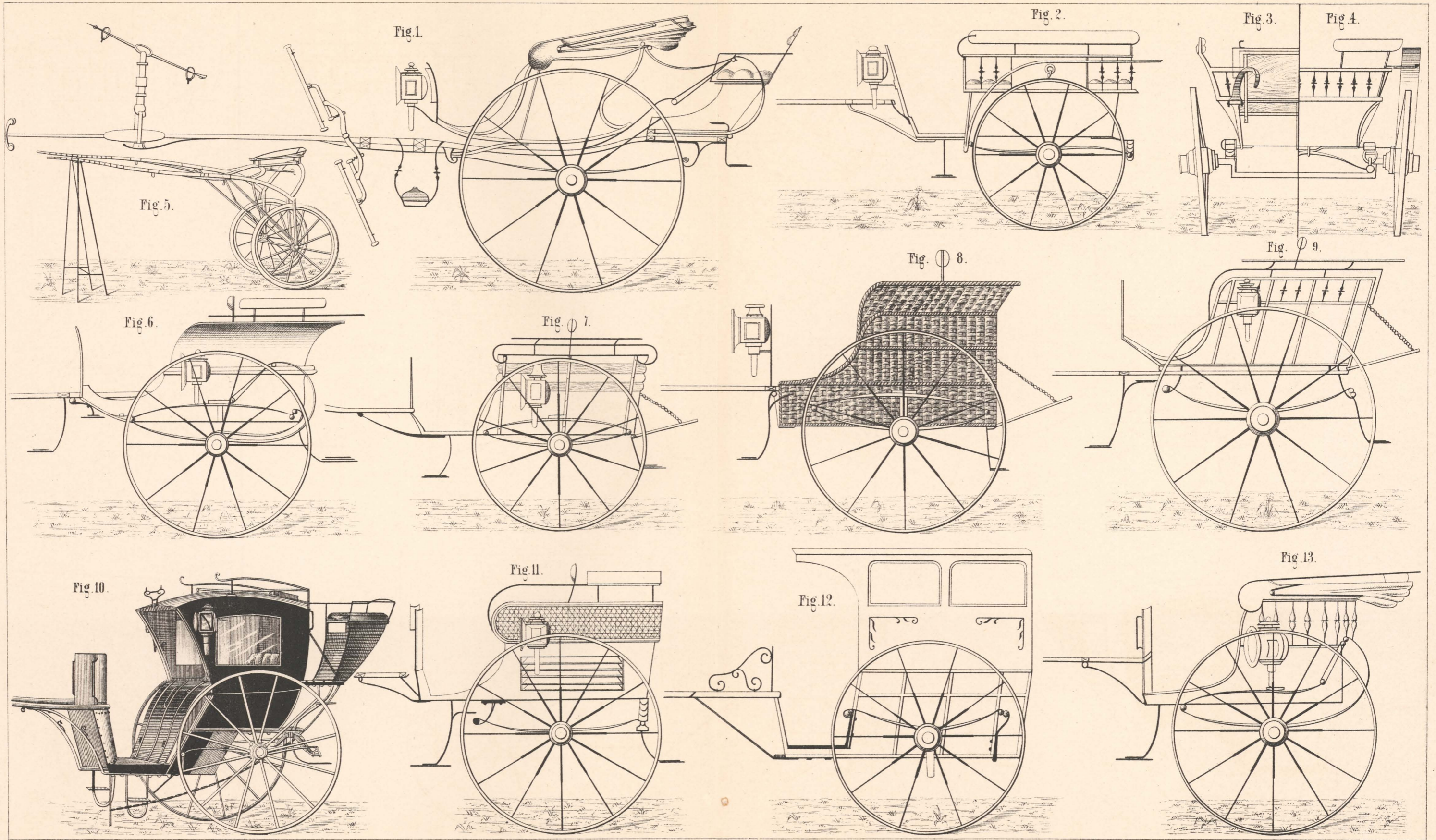


Fig. 1.

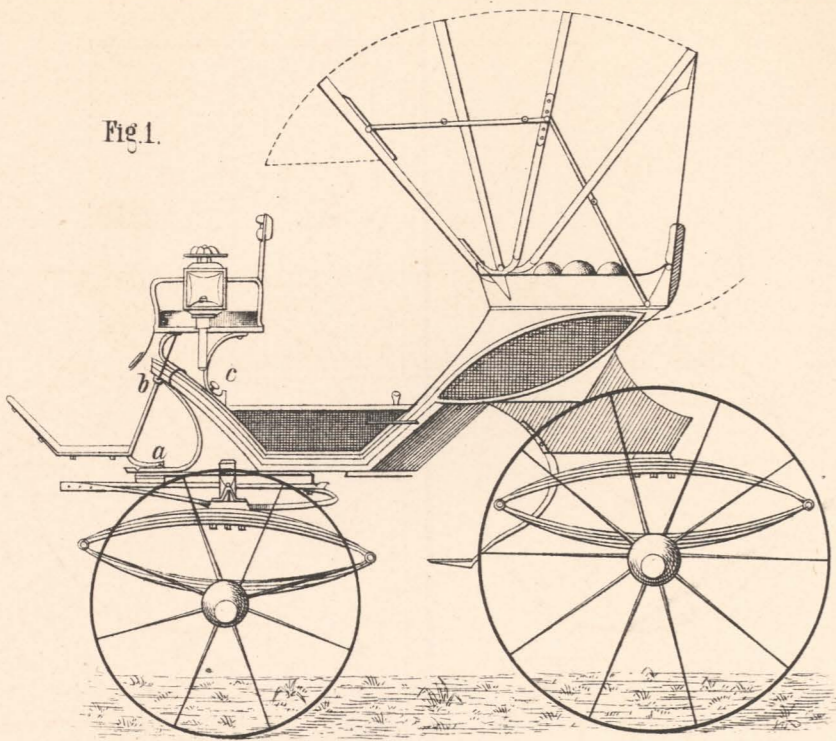


Fig. 2.

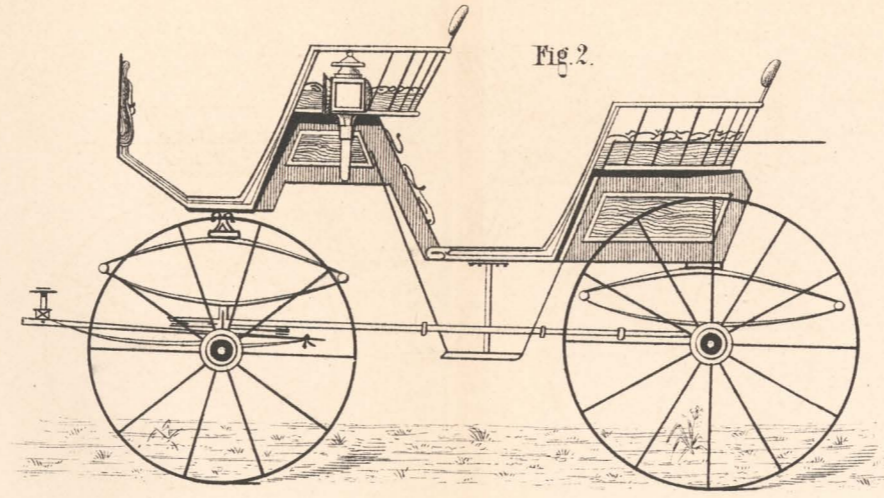


Fig. 3.

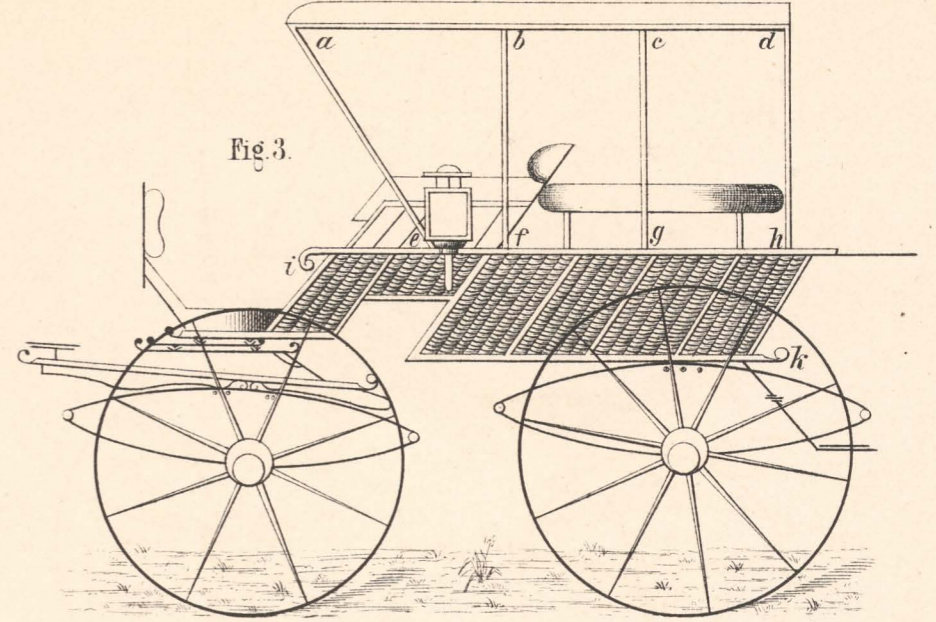


Fig. 4.

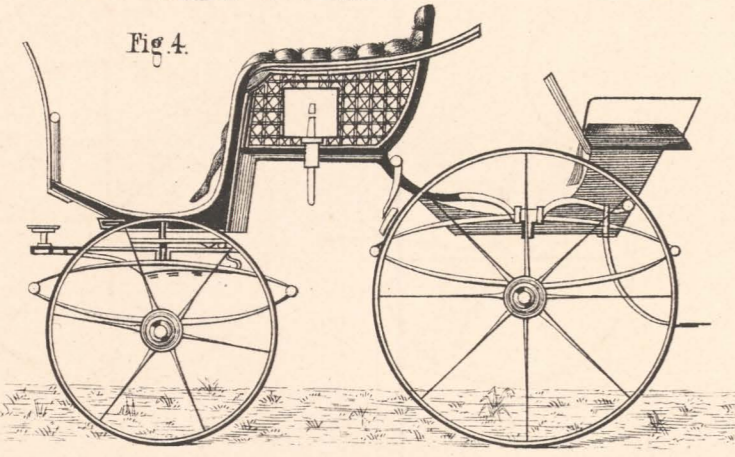


Fig. 5.

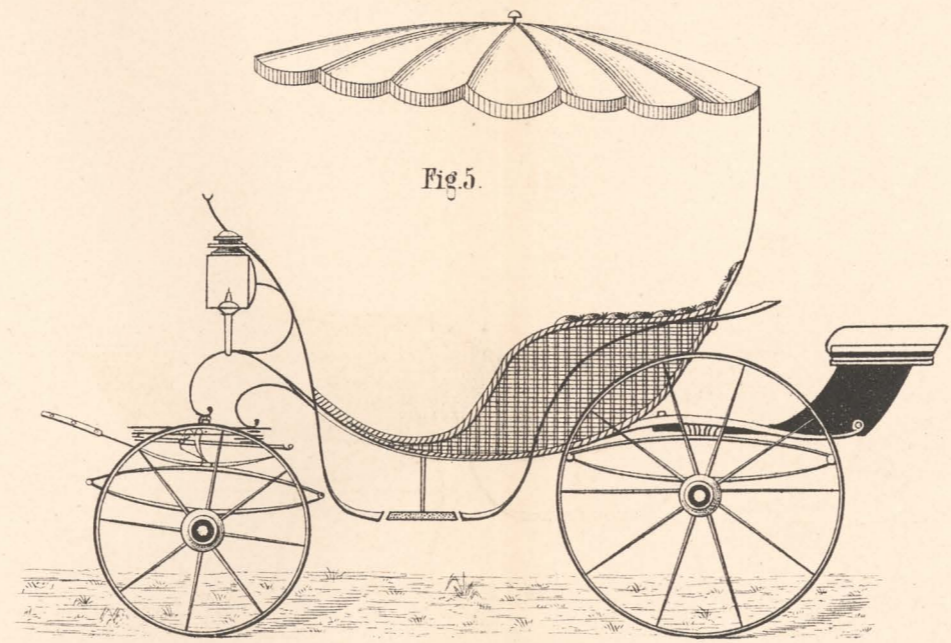


Fig. 6.

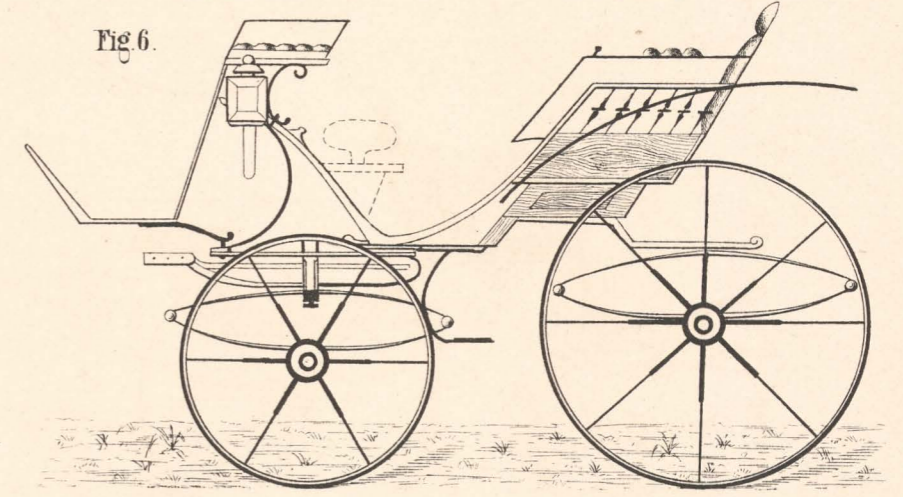


Fig. 7.

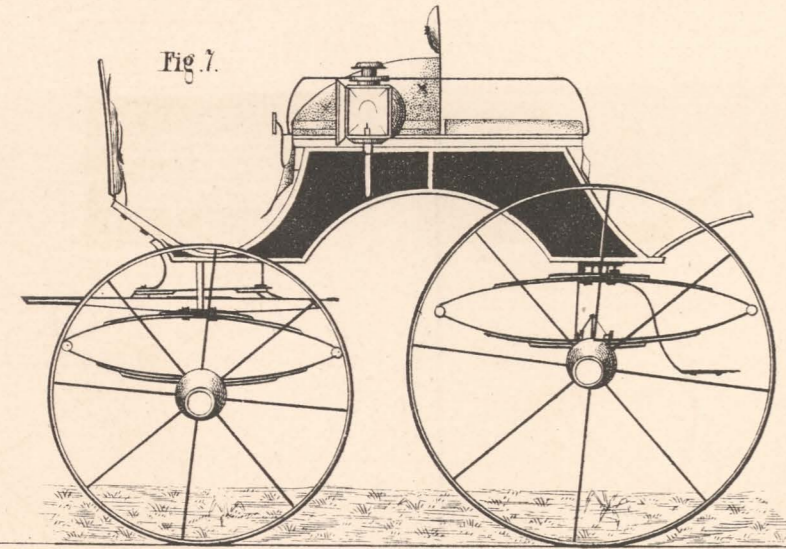


Fig. 8.

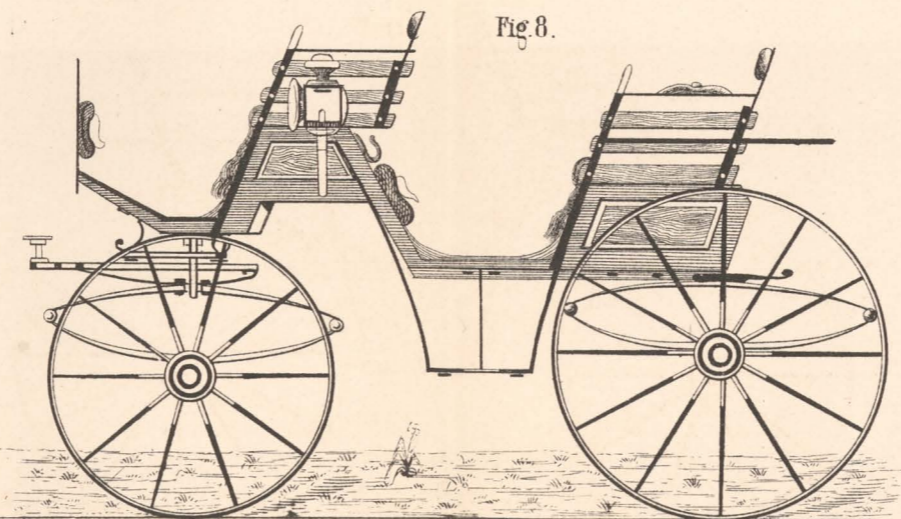
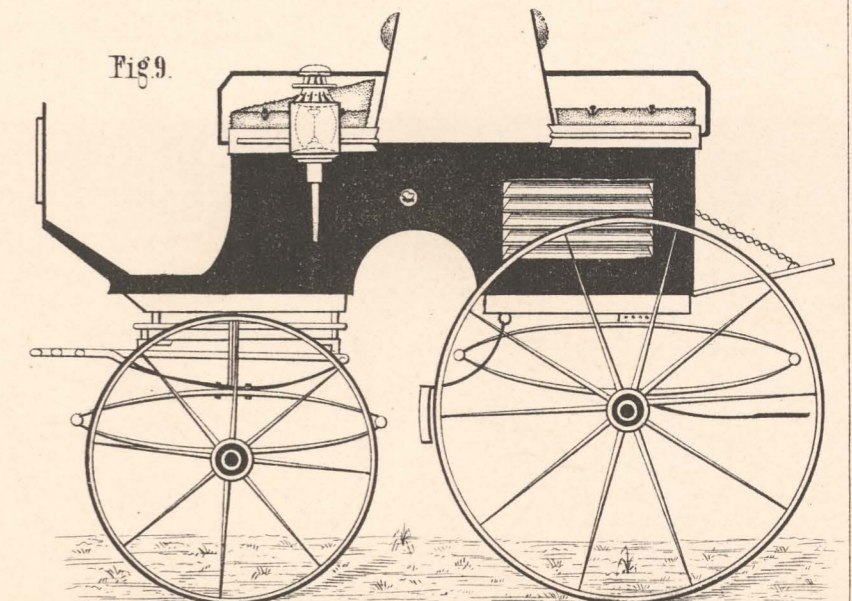


Fig. 9.



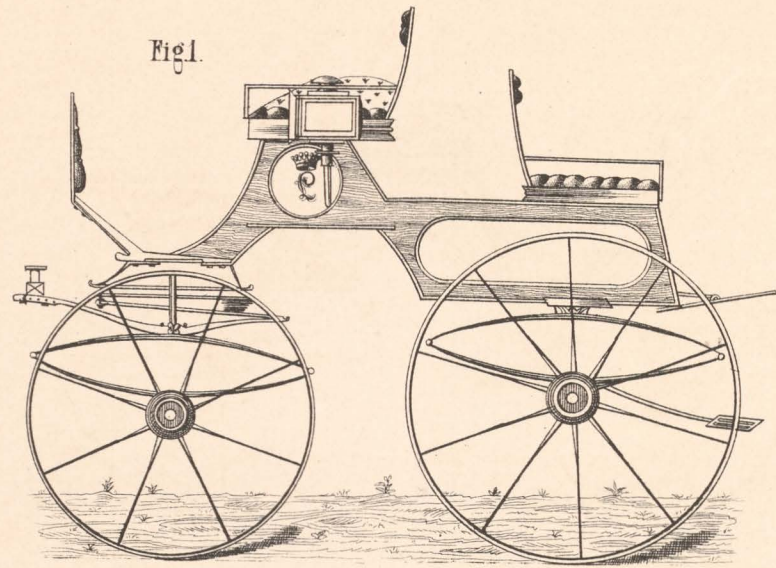


Fig. 1.

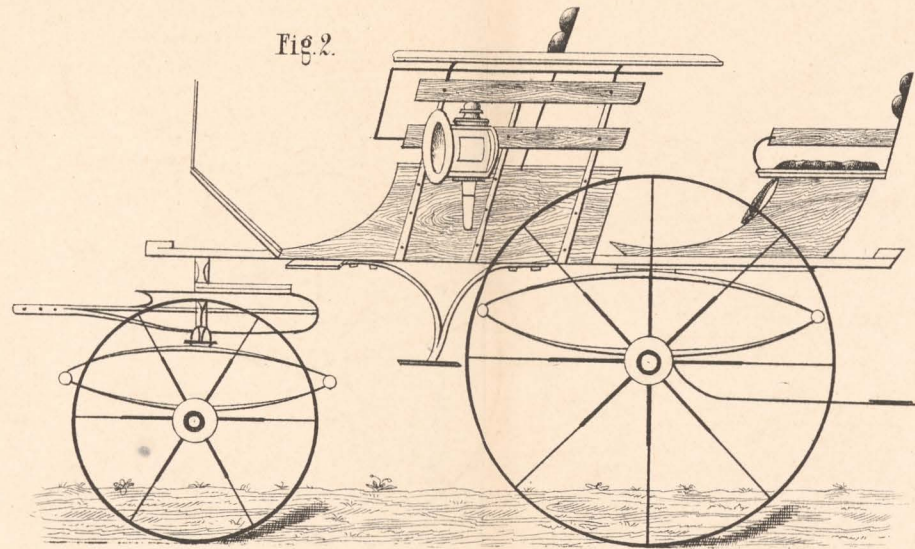


Fig. 2.

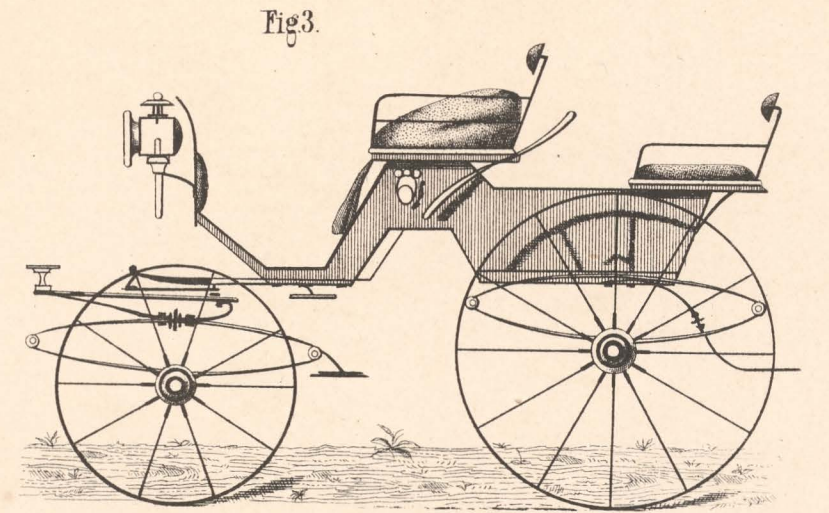


Fig. 3.

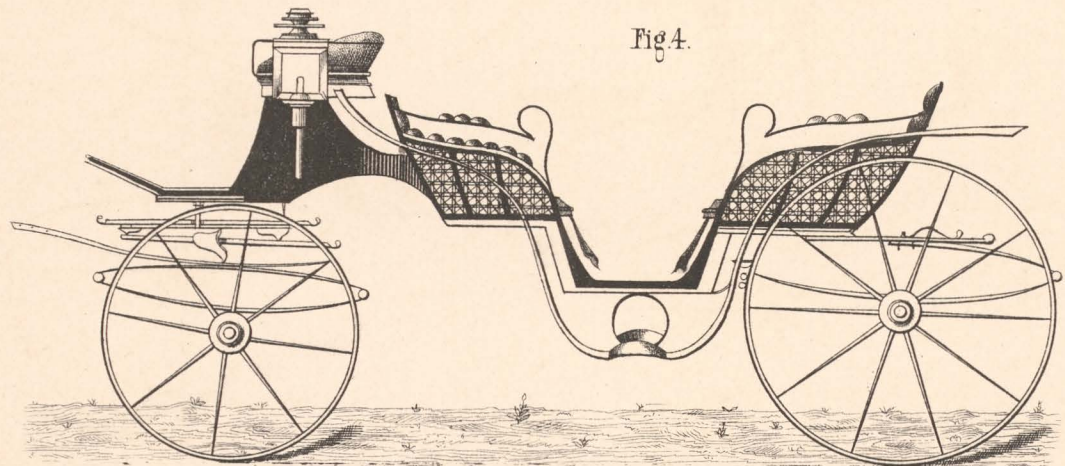


Fig. 4.

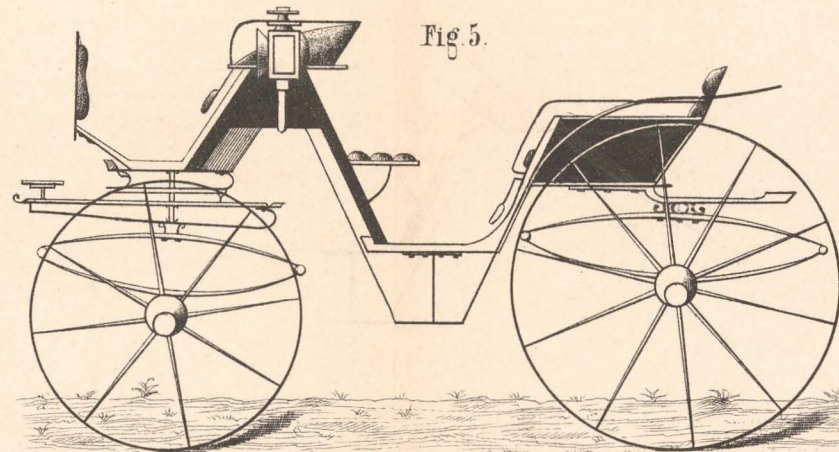


Fig. 5.

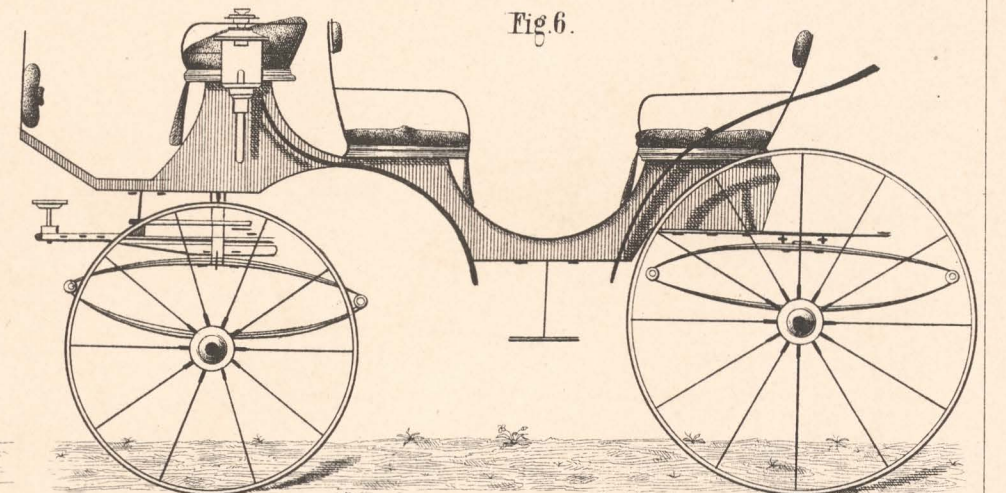


Fig. 6.

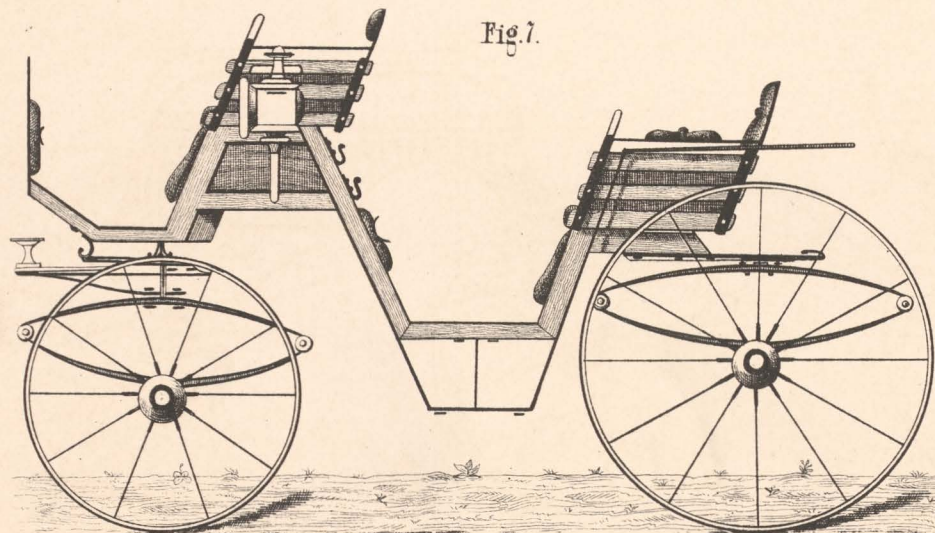


Fig. 7.

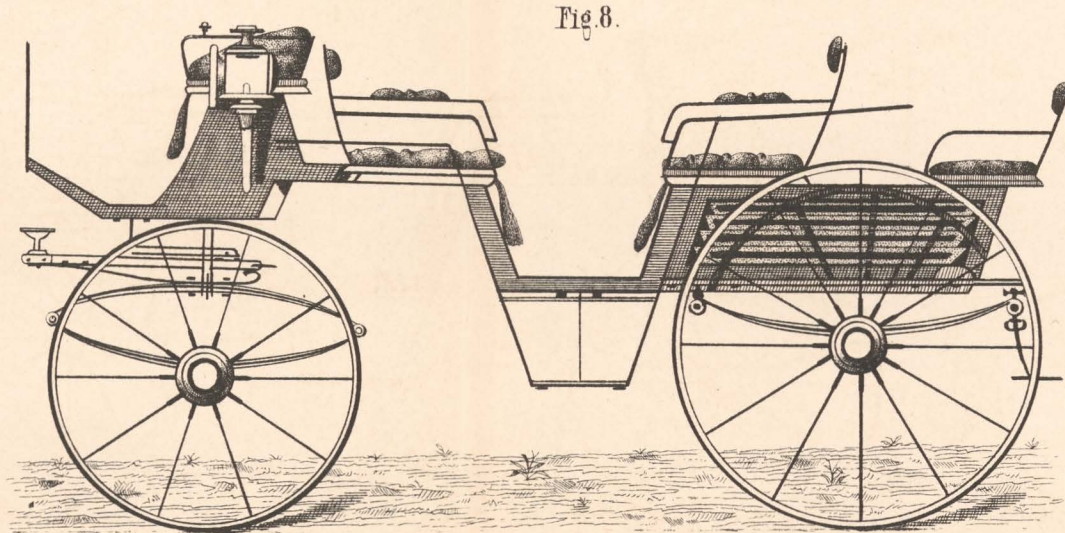


Fig. 8.

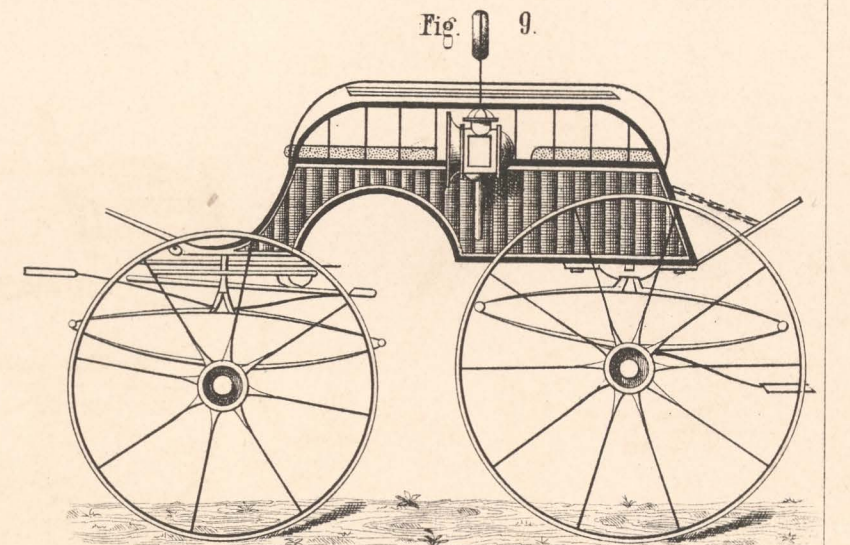
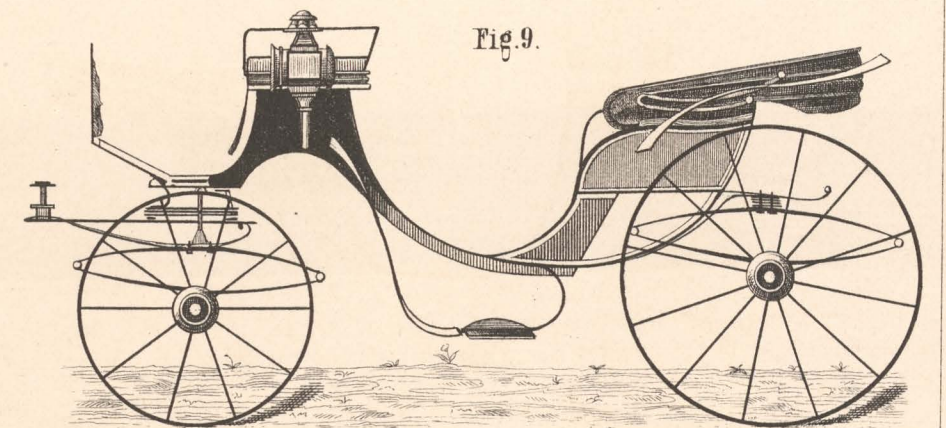
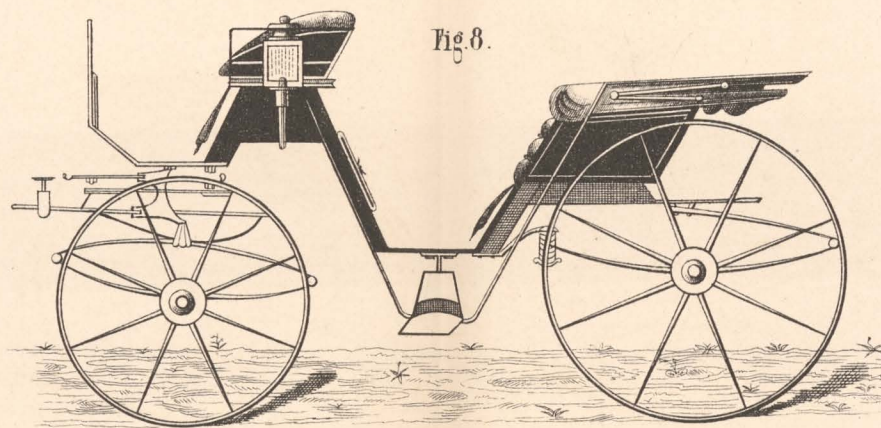
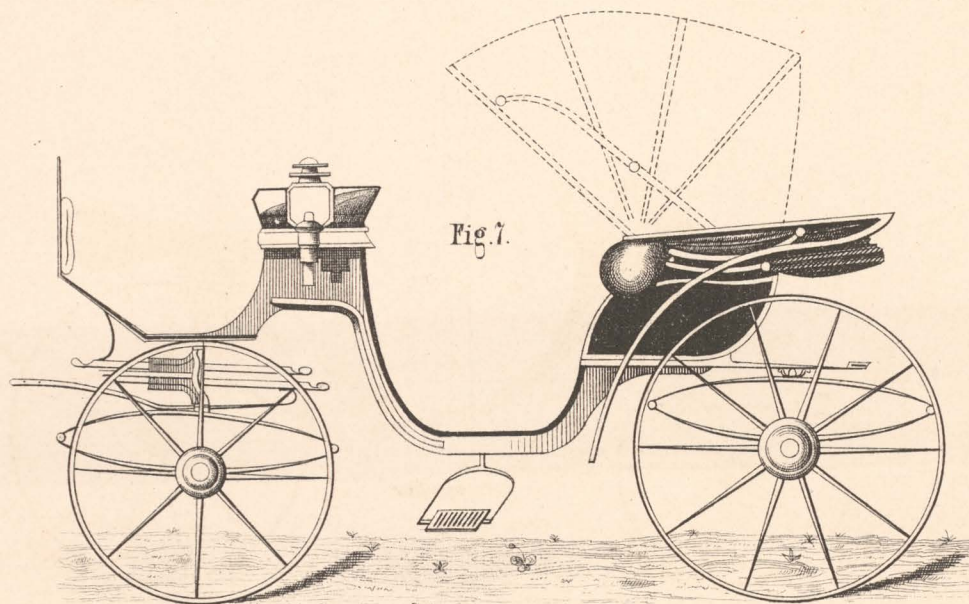
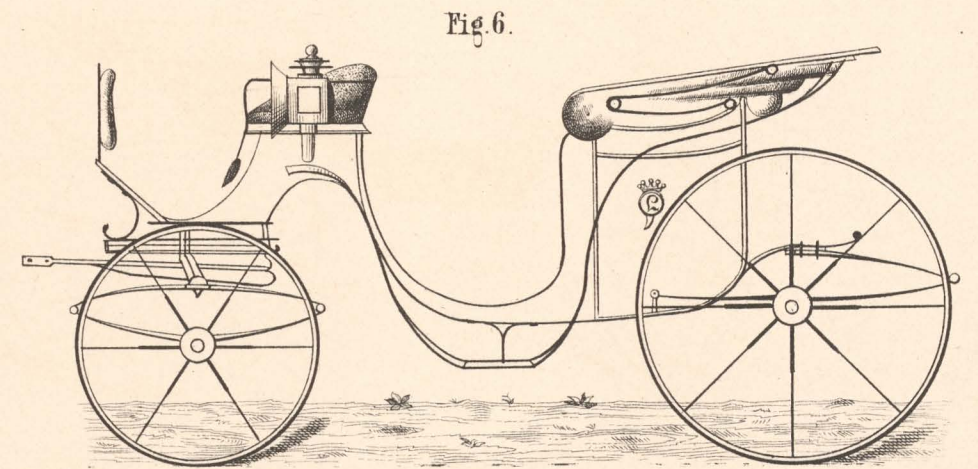
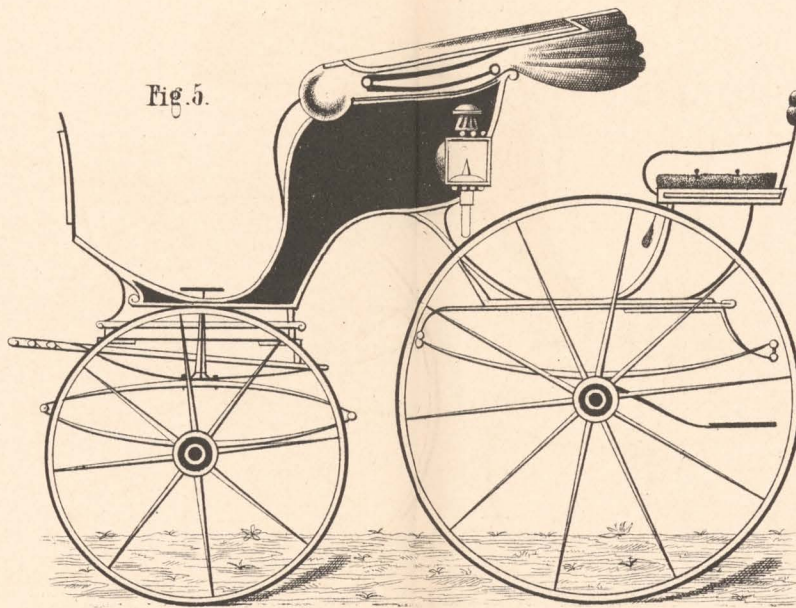
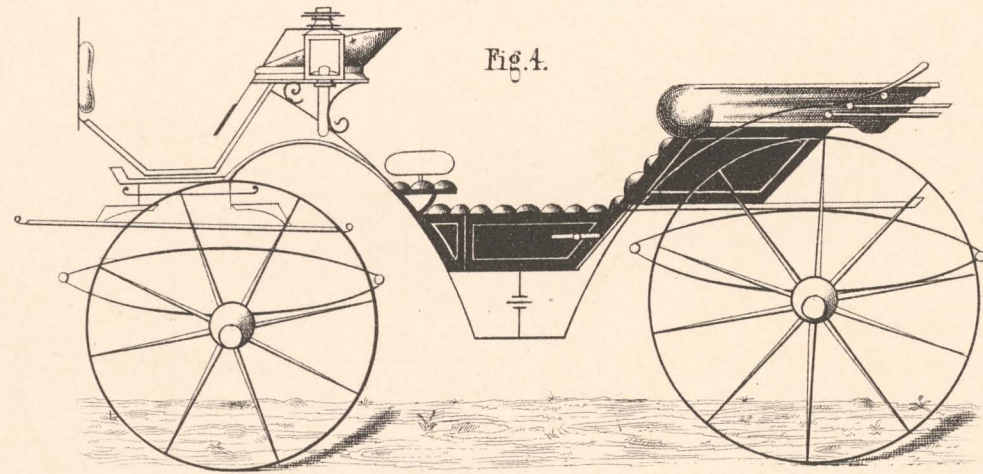
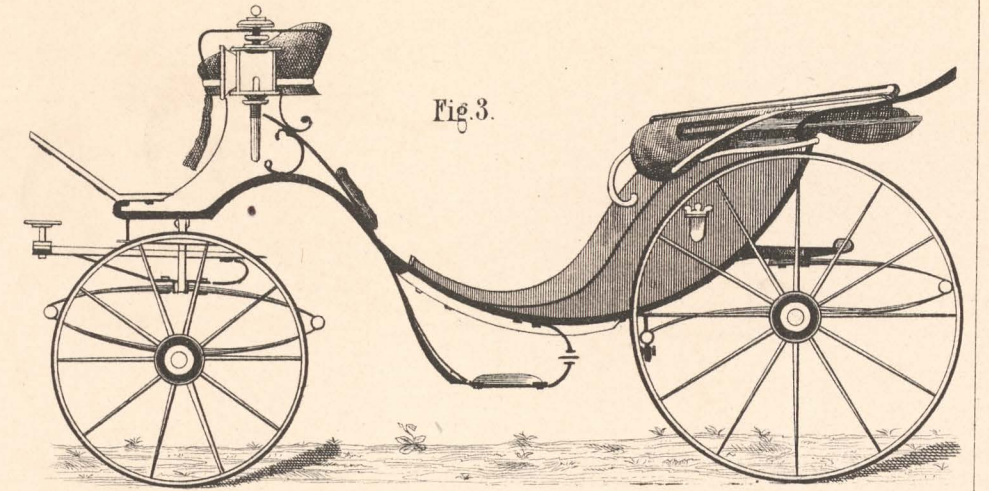
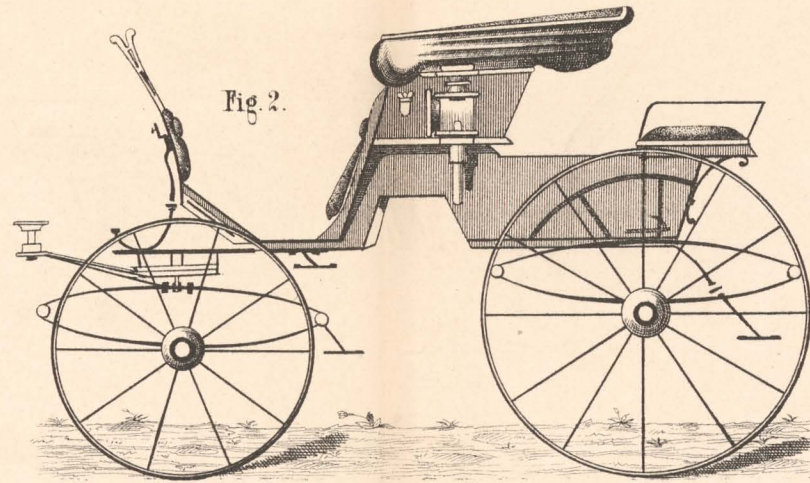
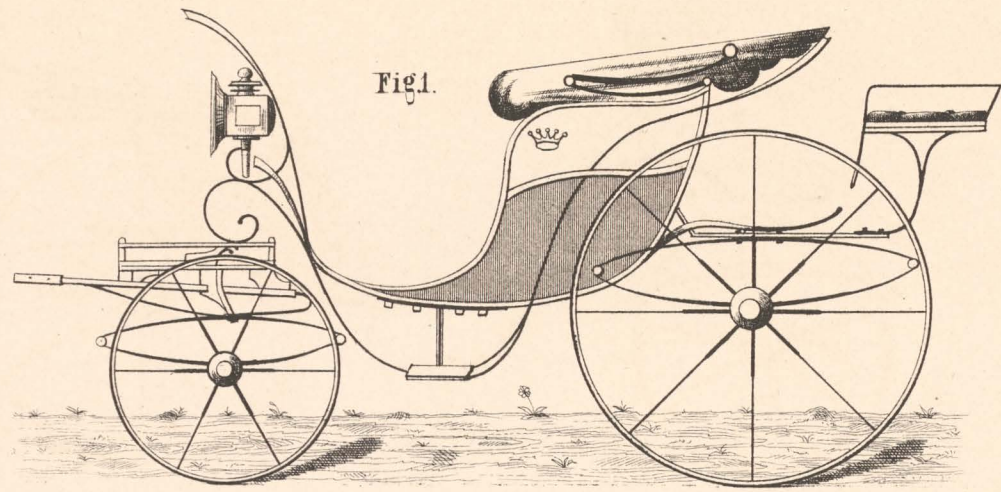


Fig. 9.



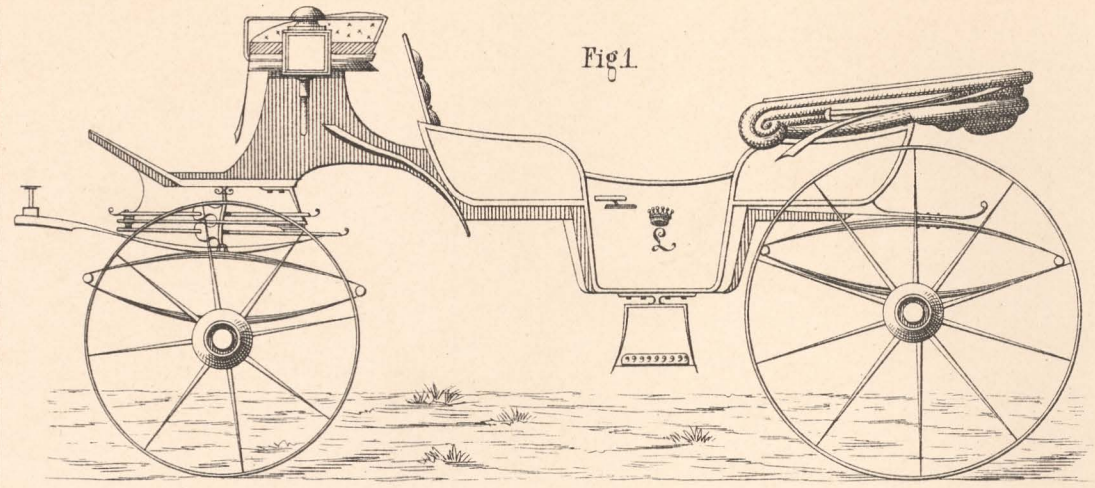


Fig. 1.

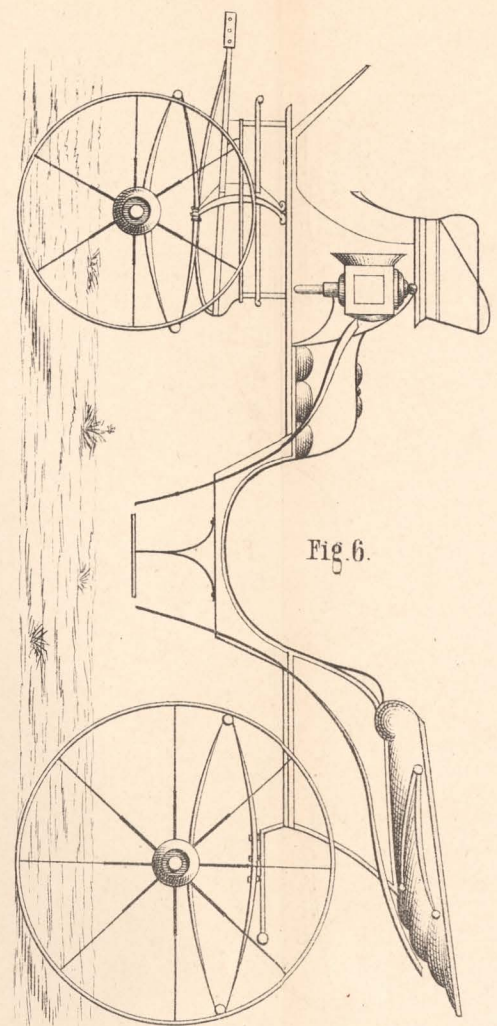


Fig. 6.

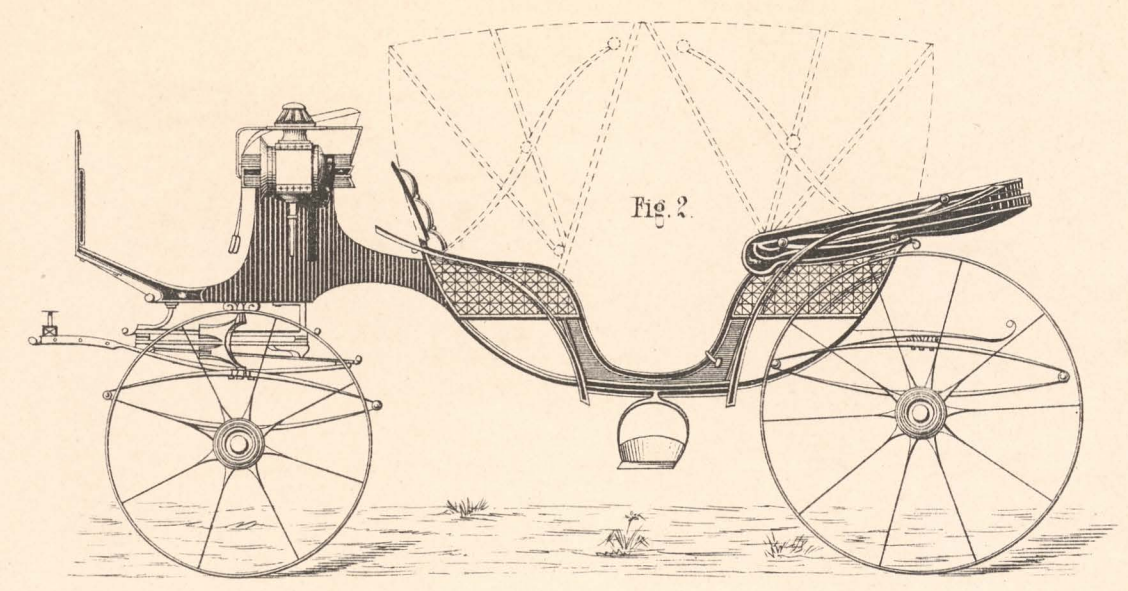


Fig. 2.

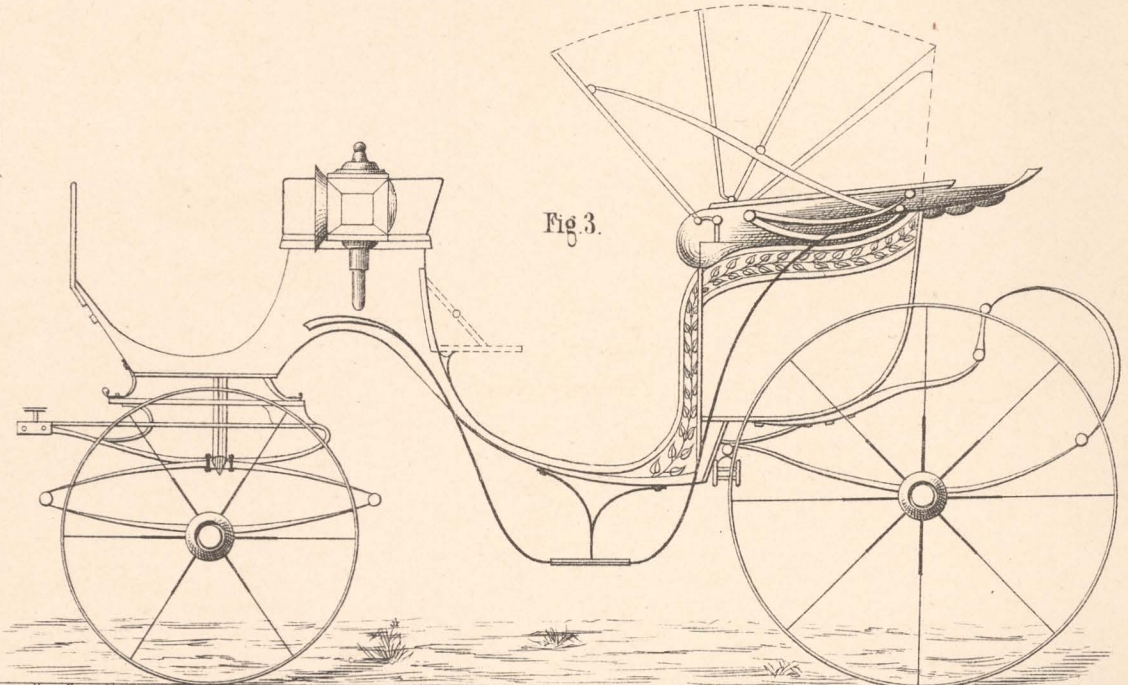


Fig. 3.

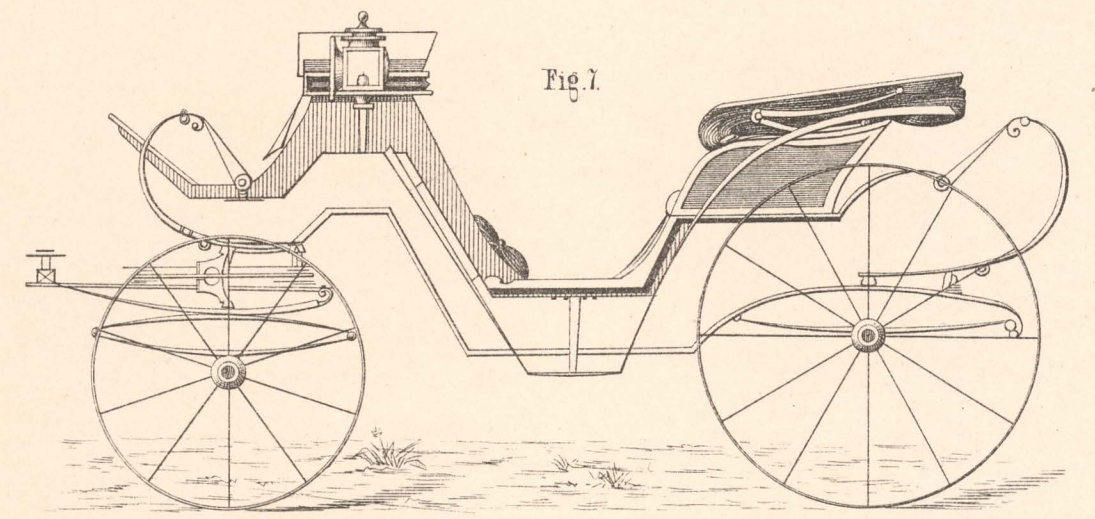


Fig. 7.

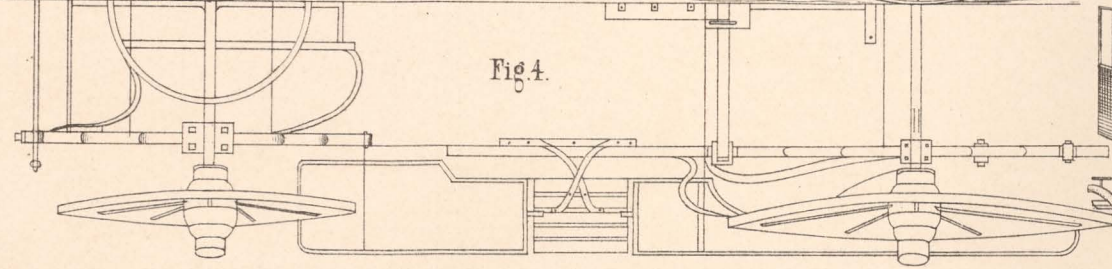


Fig. 4.

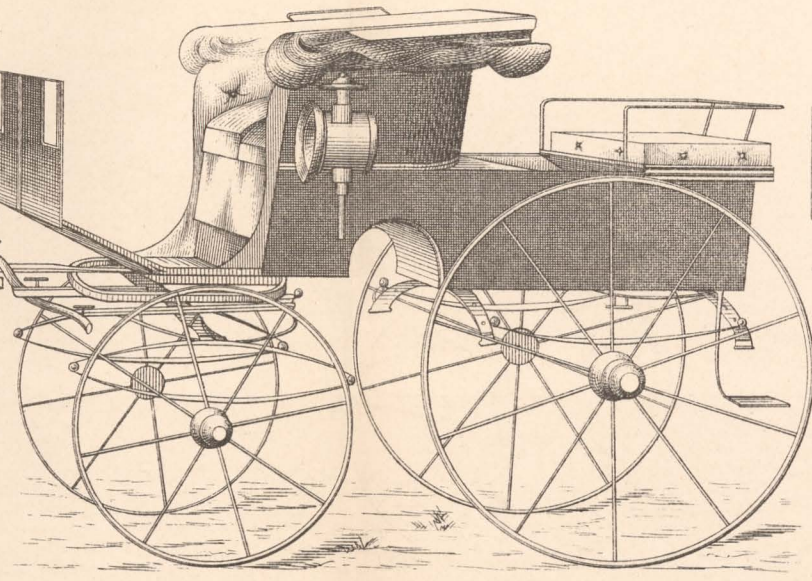


Fig. 8.

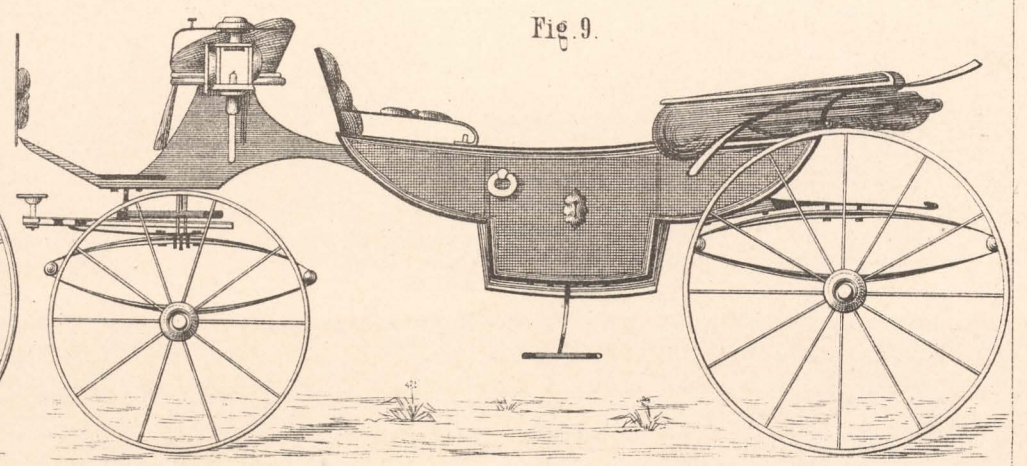


Fig. 9.

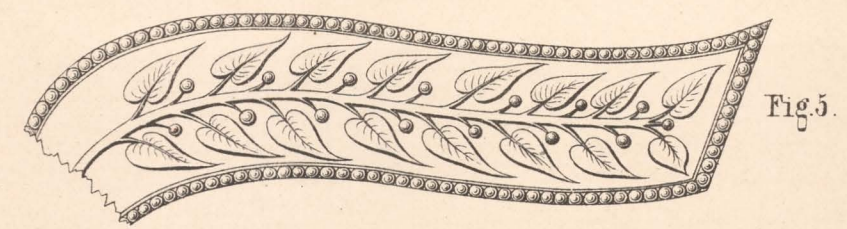
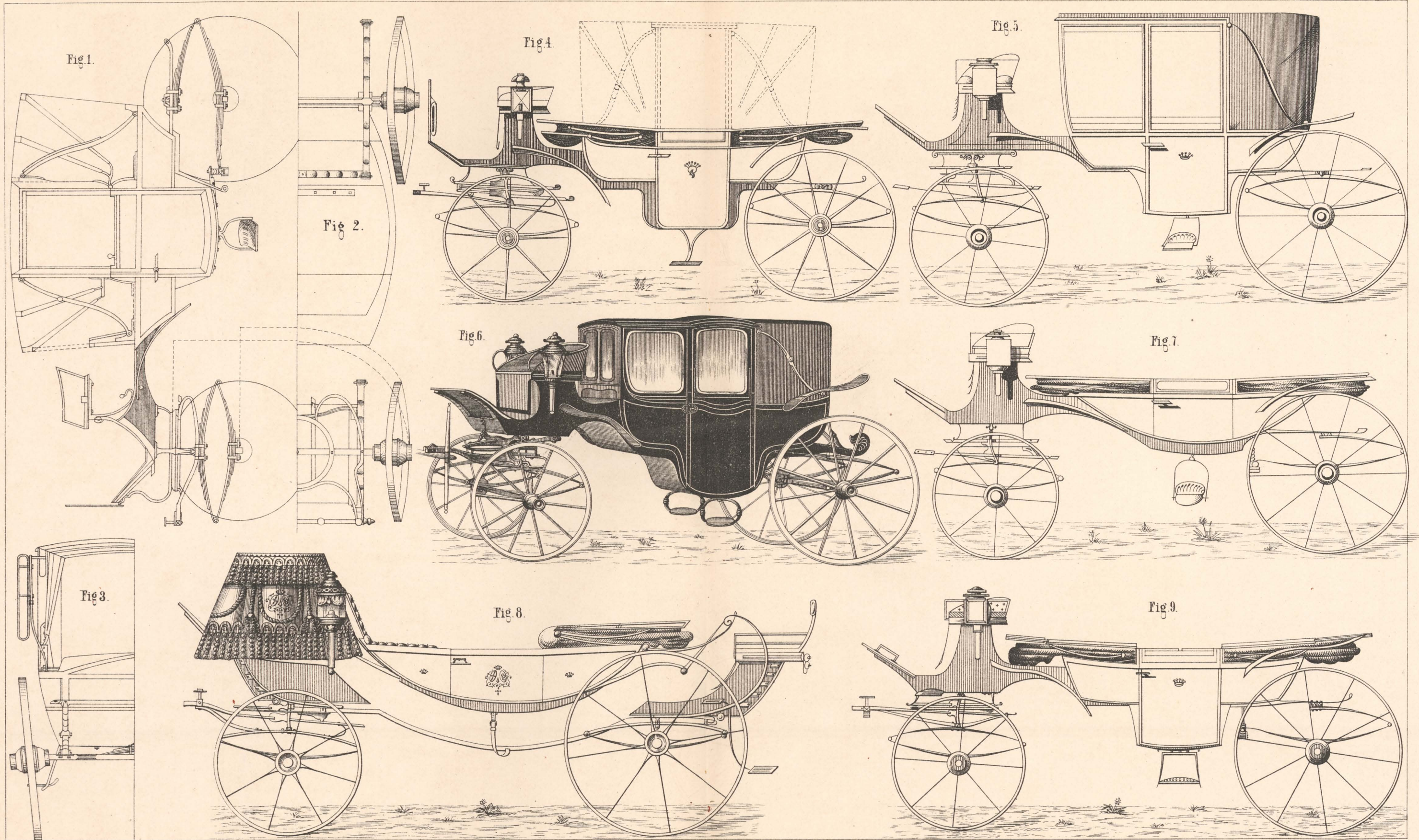


Fig. 5.



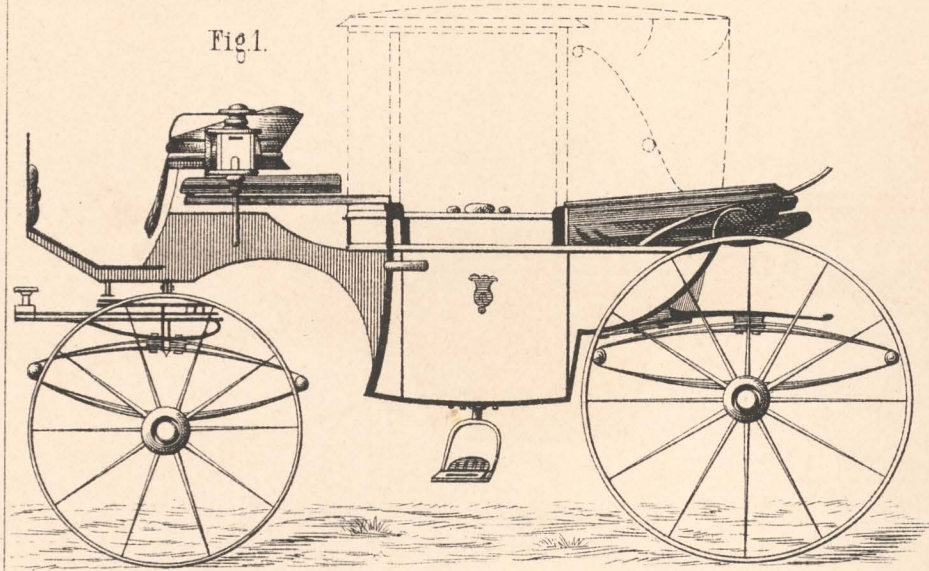


Fig. 1.

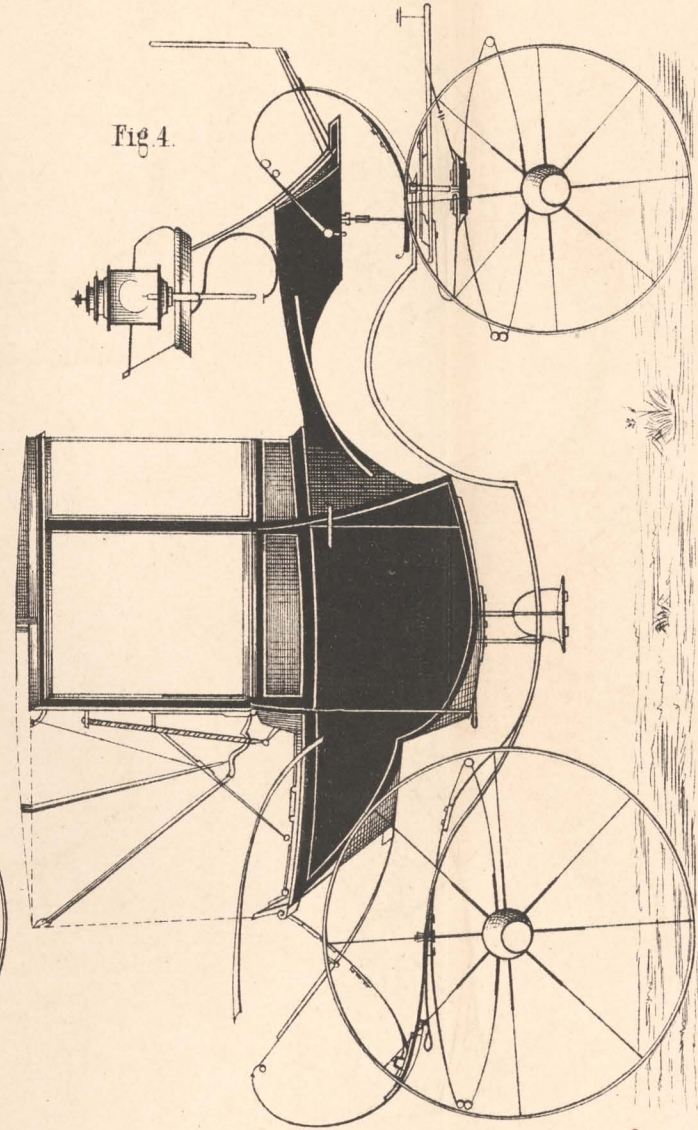


Fig. 4.

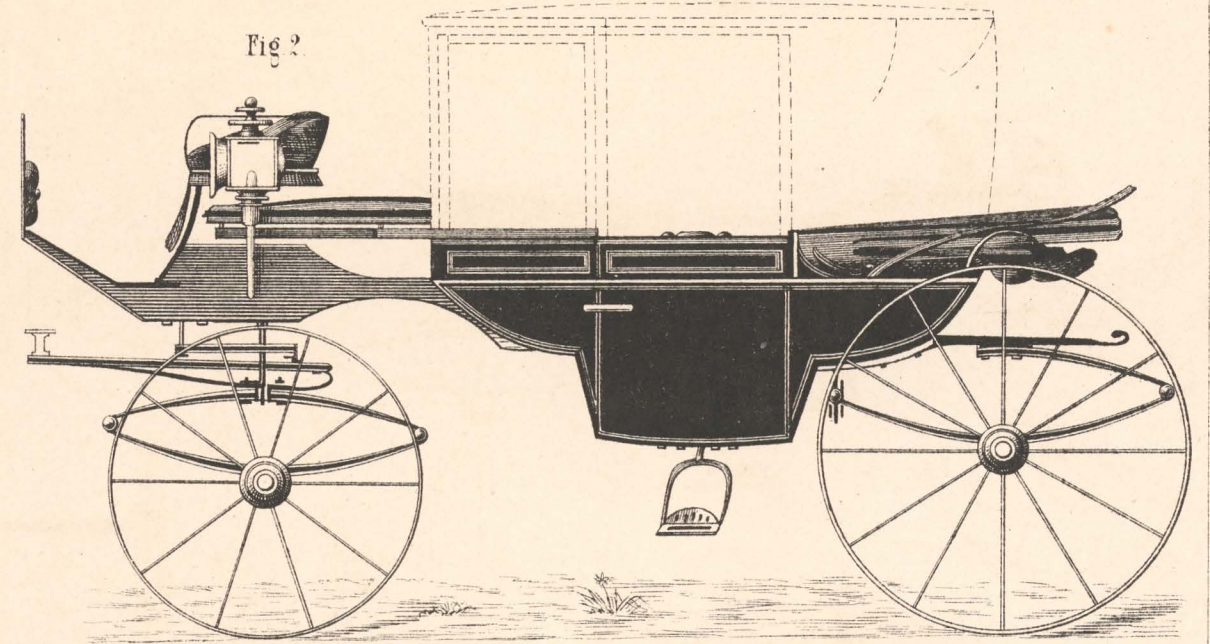


Fig. 2.

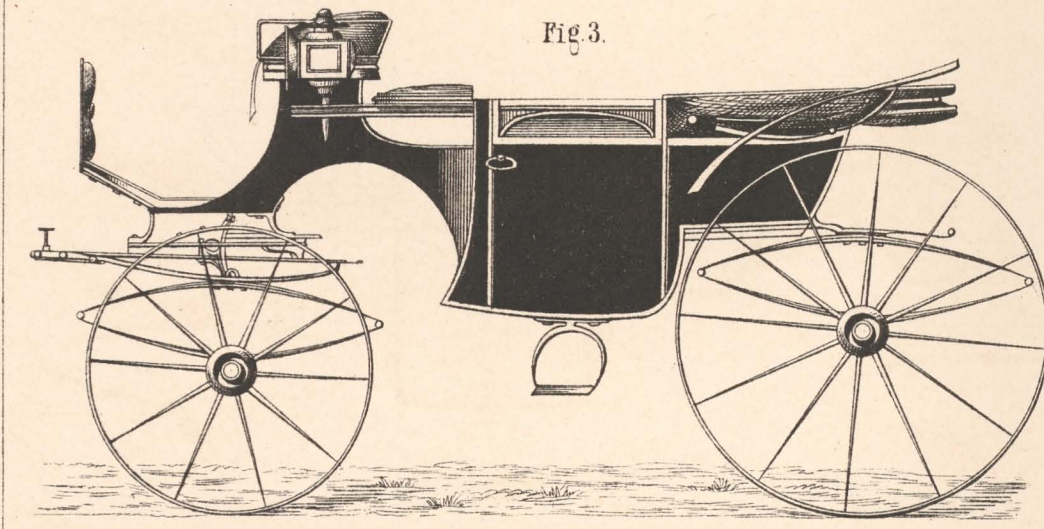


Fig. 3.

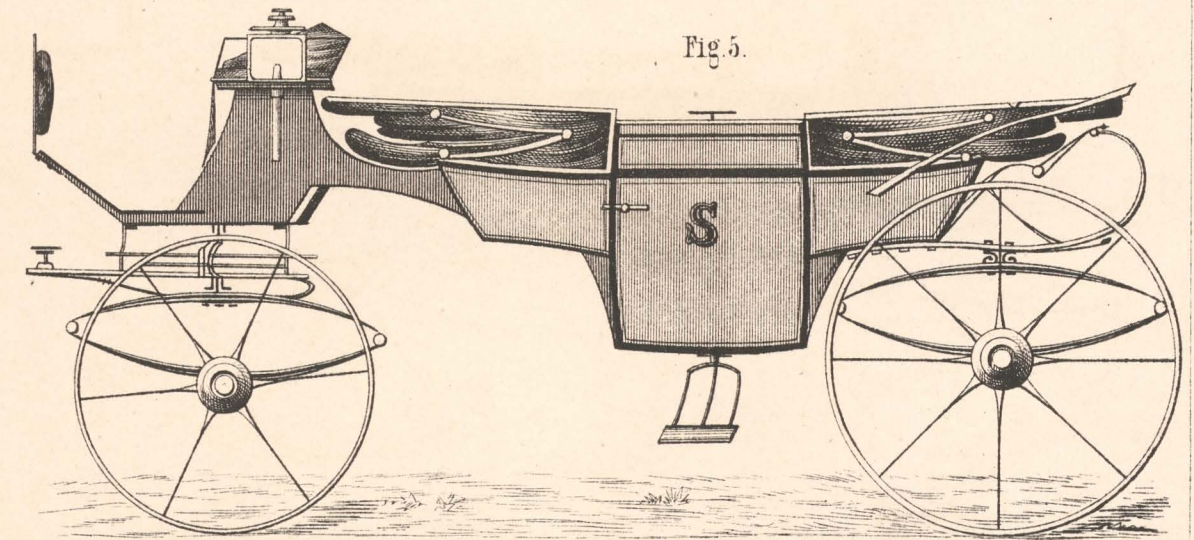


Fig. 5.

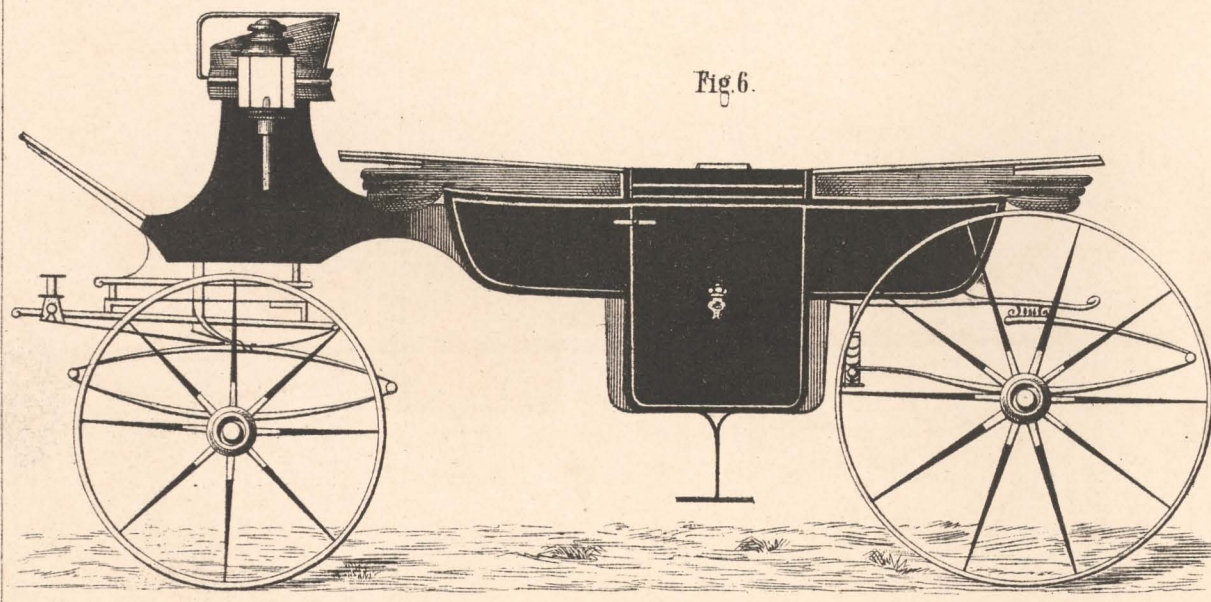


Fig. 6.

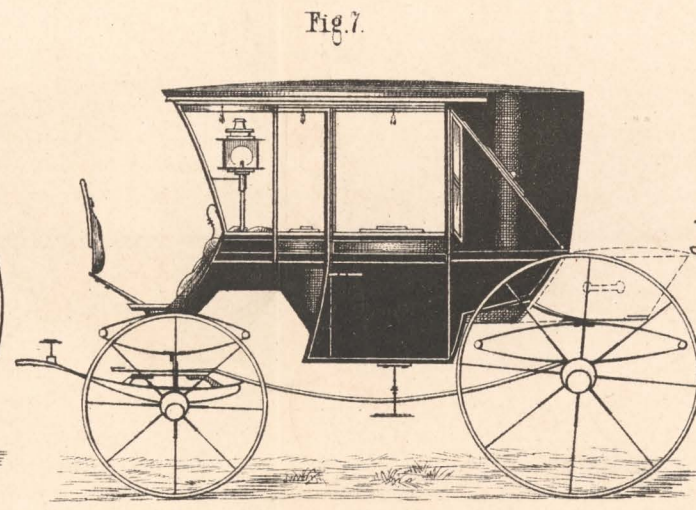


Fig. 7.

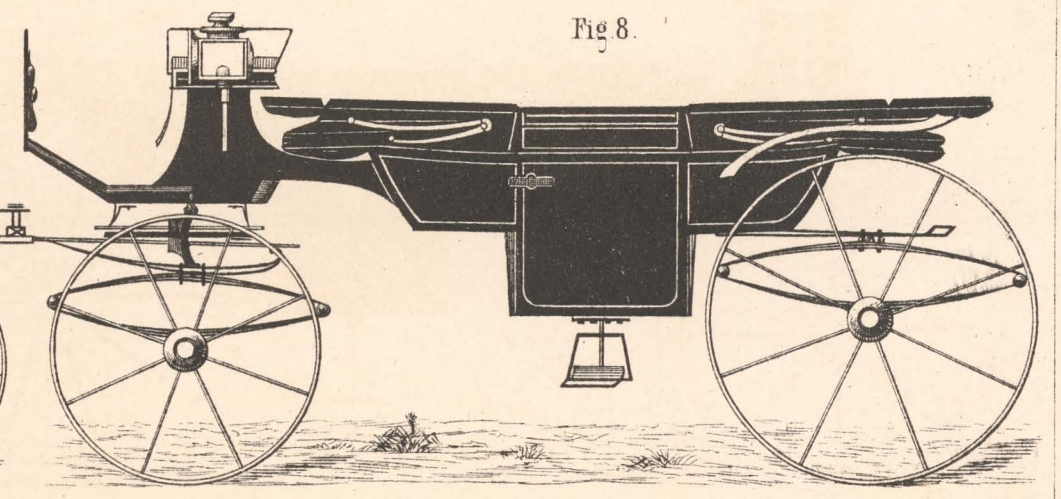
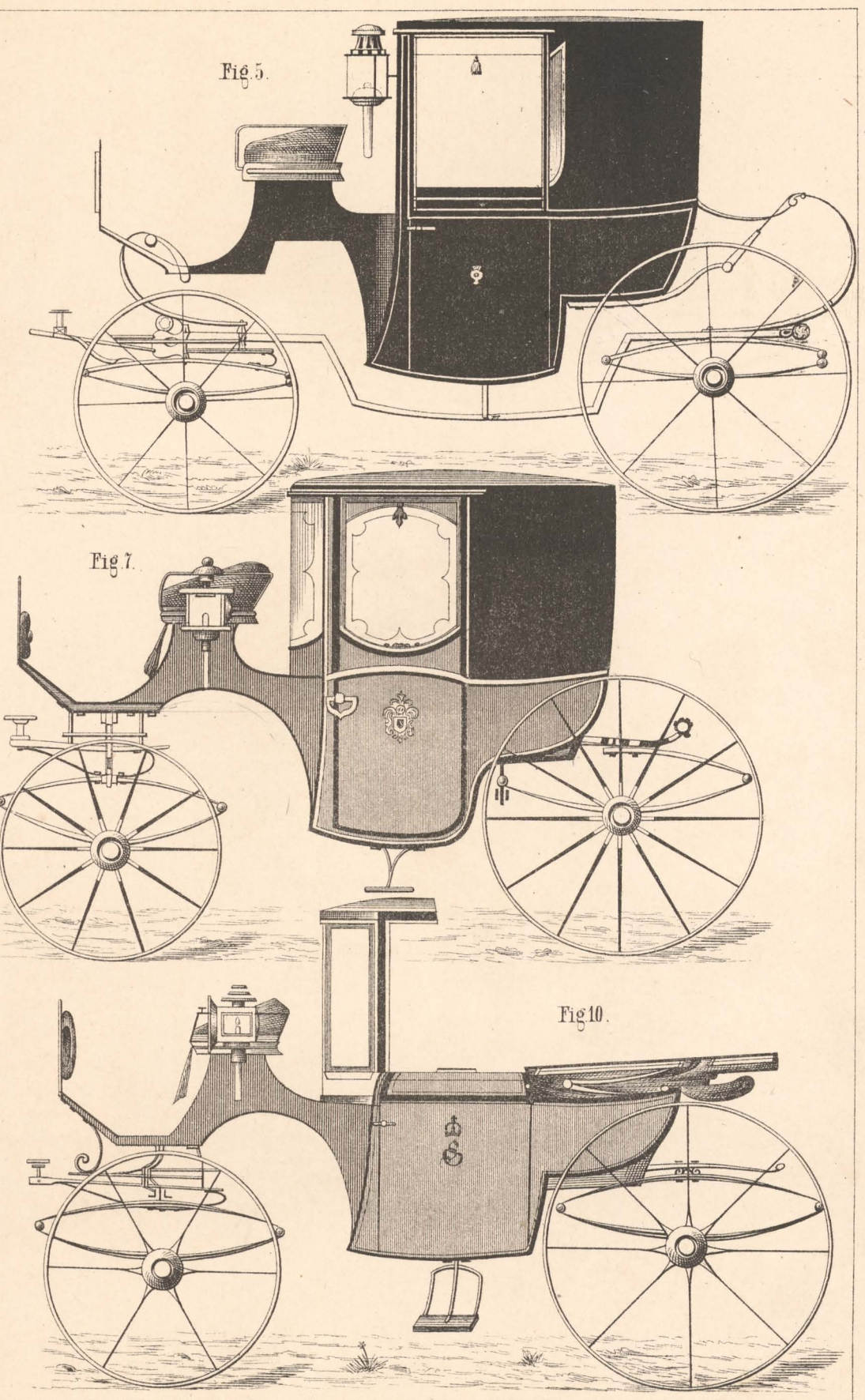
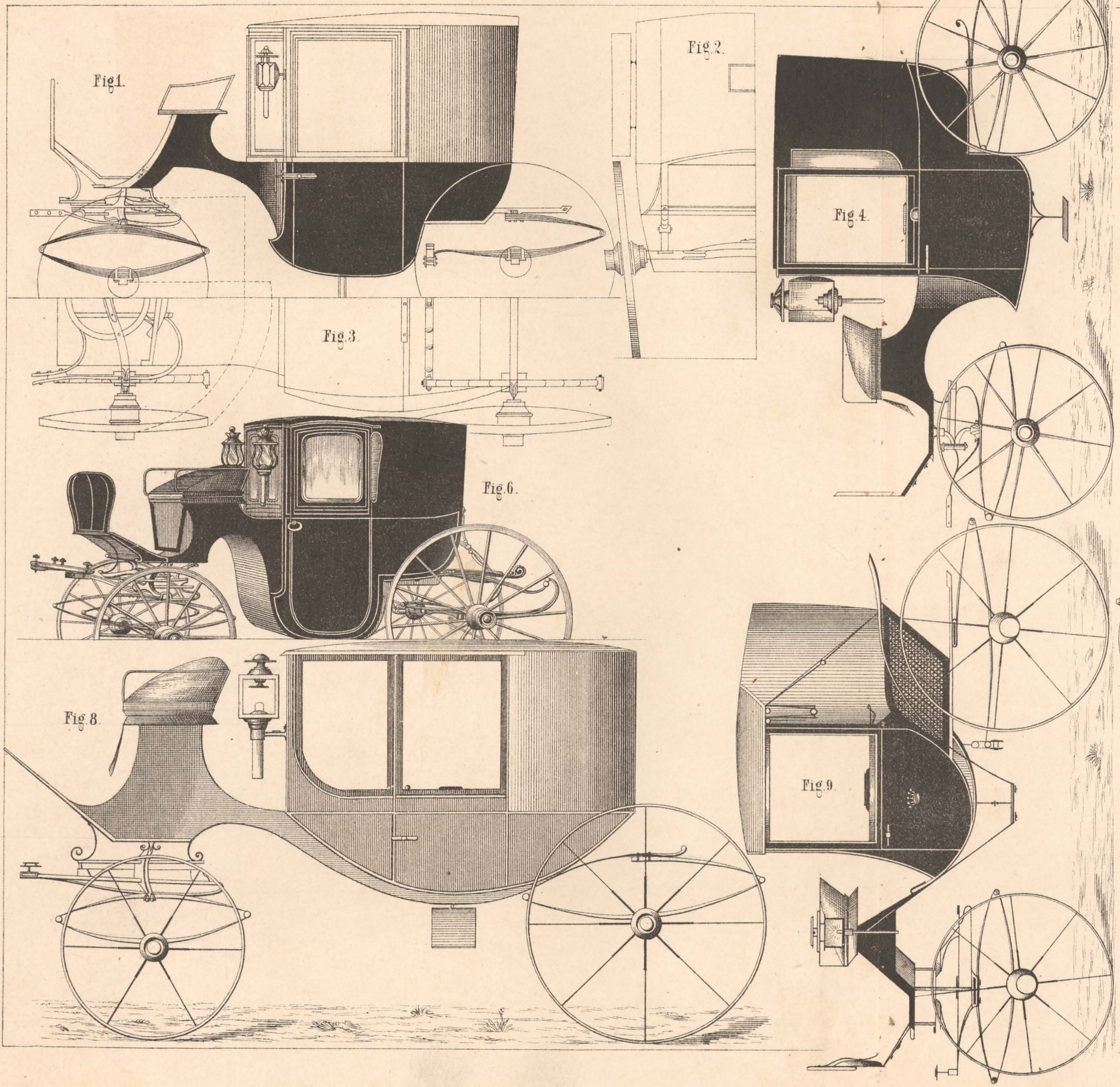


Fig. 8.



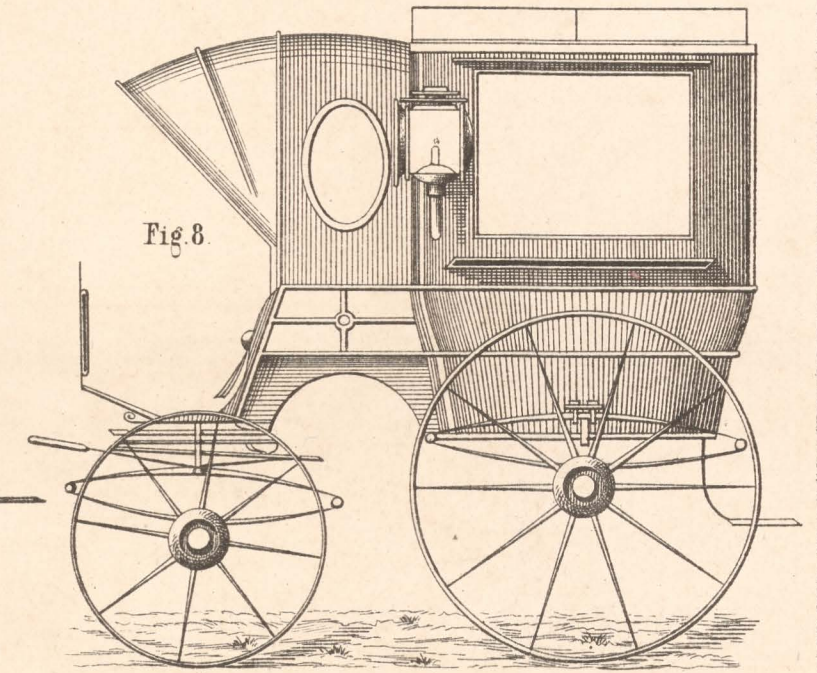
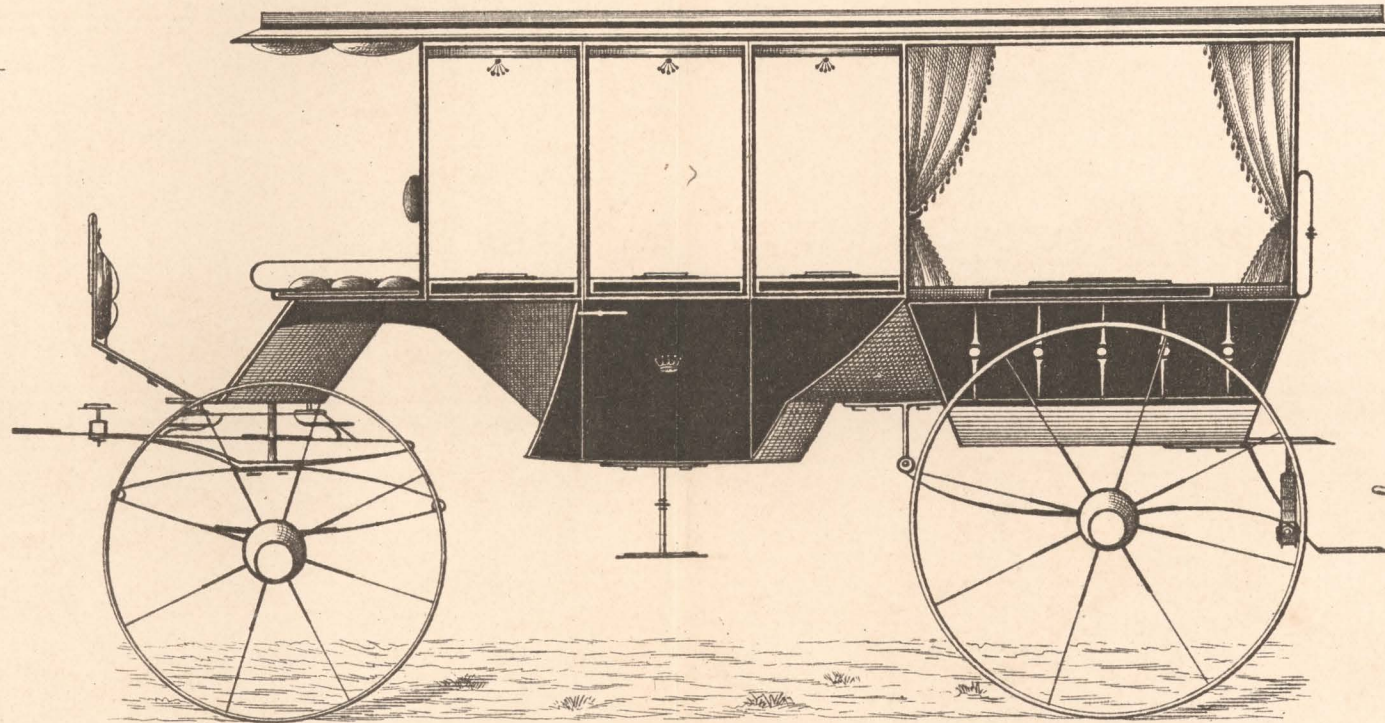
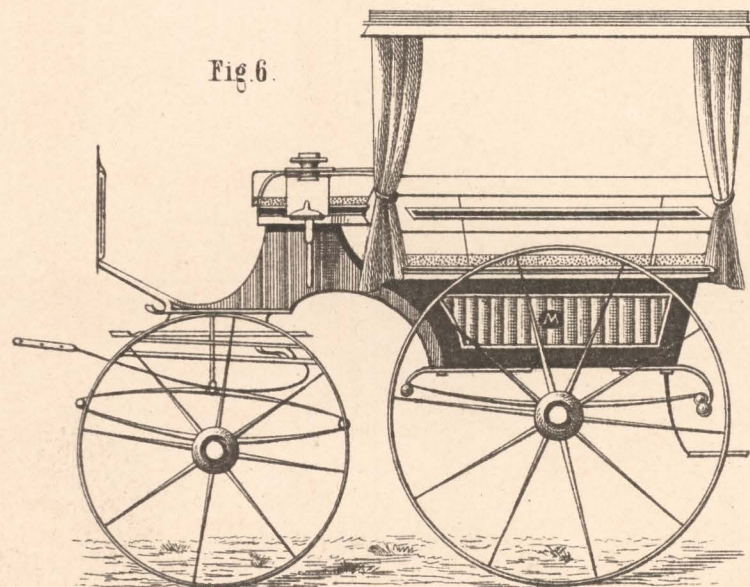
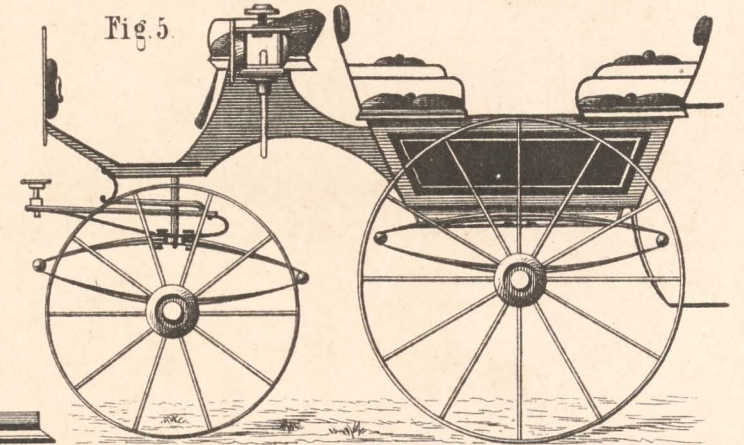
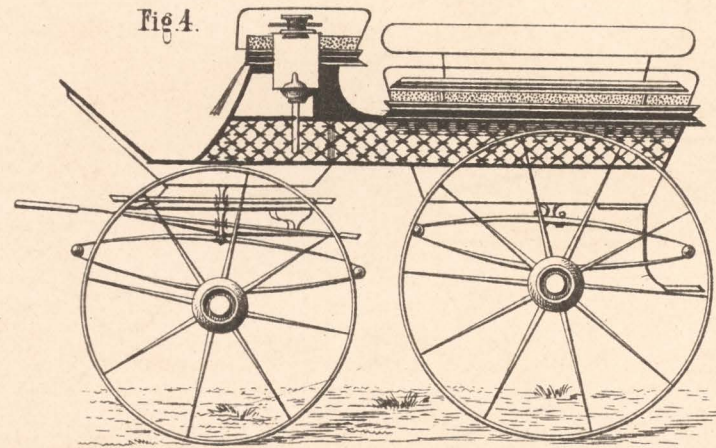
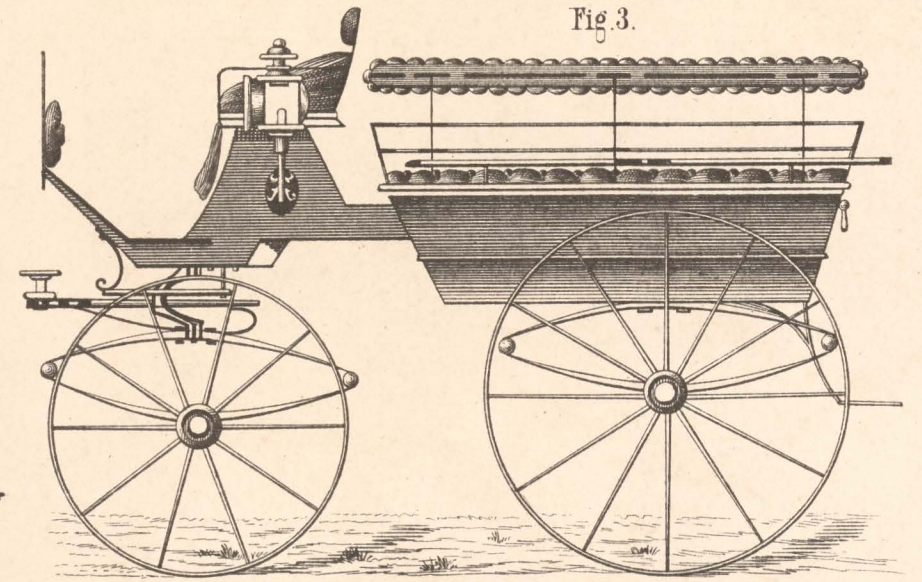
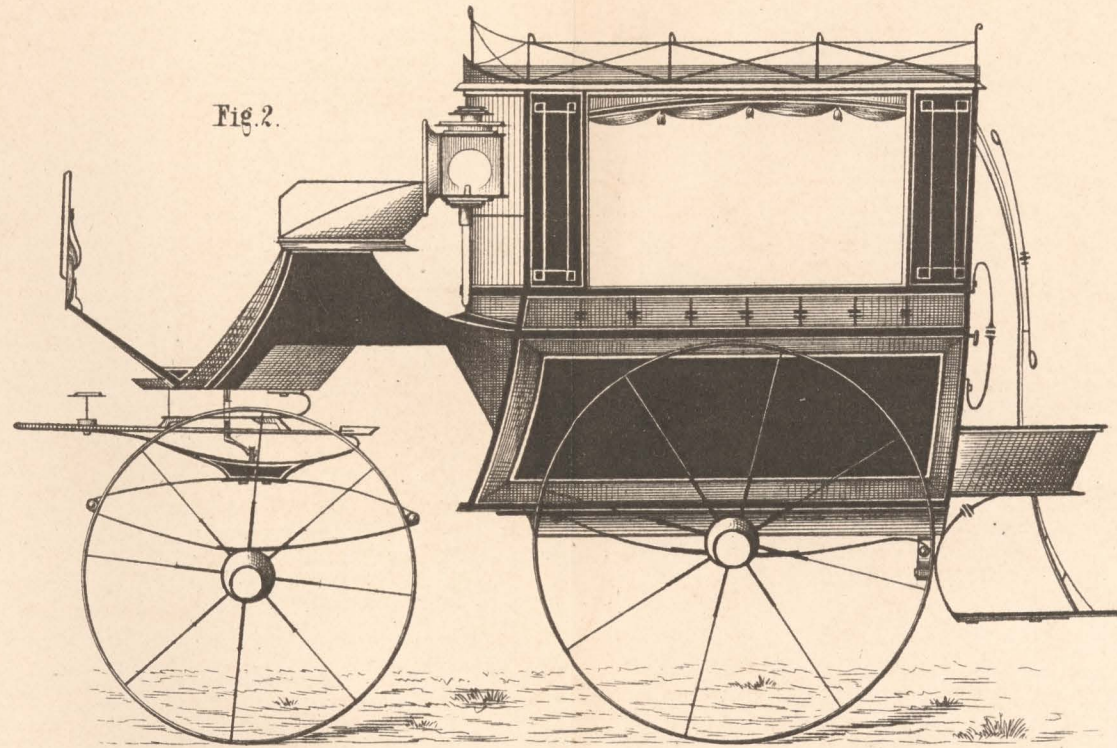
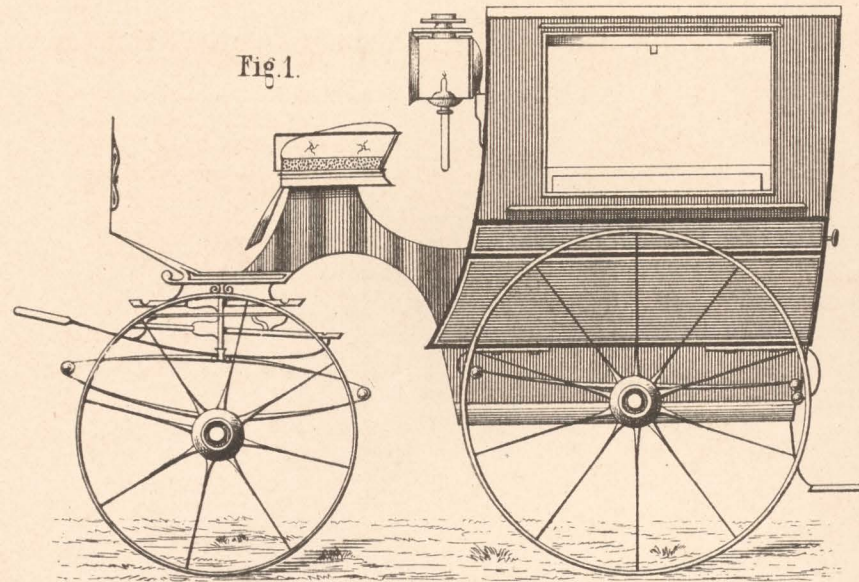


Fig. 1.

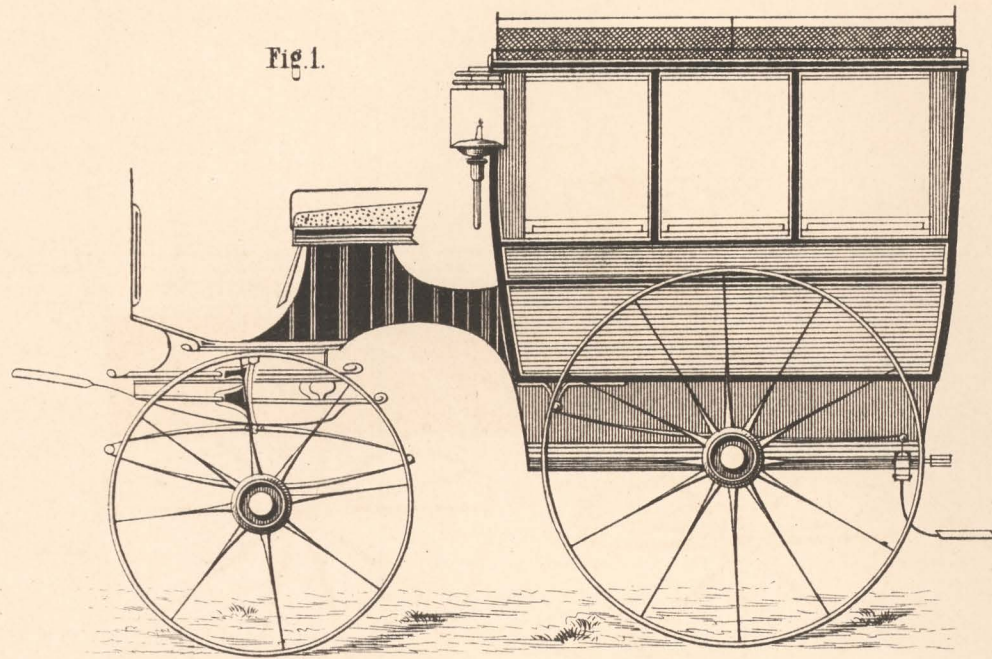


Fig. 2.

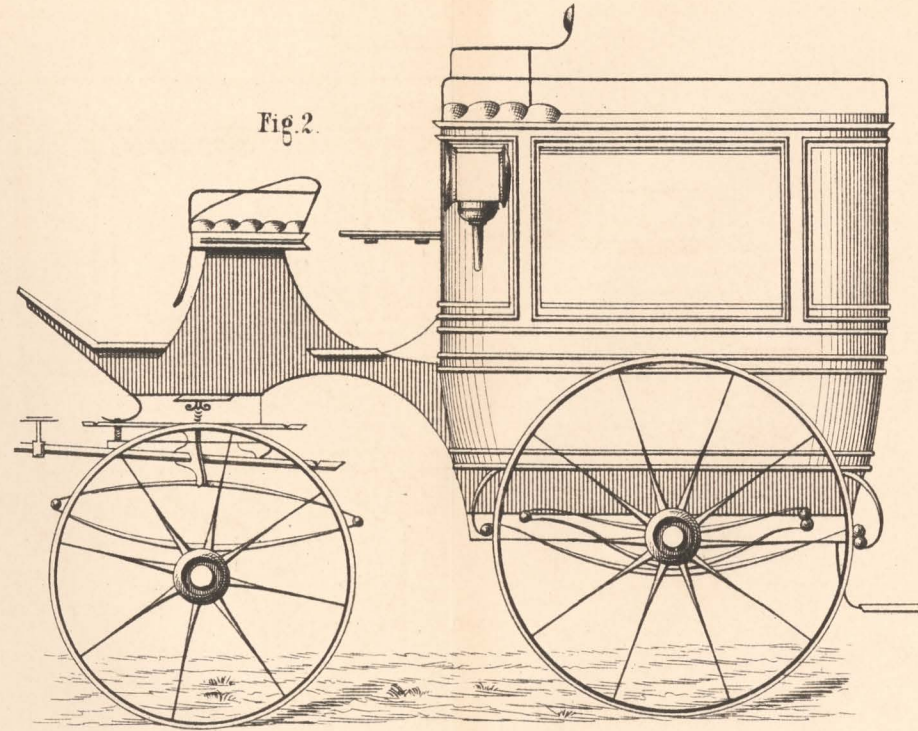


Fig. 3.

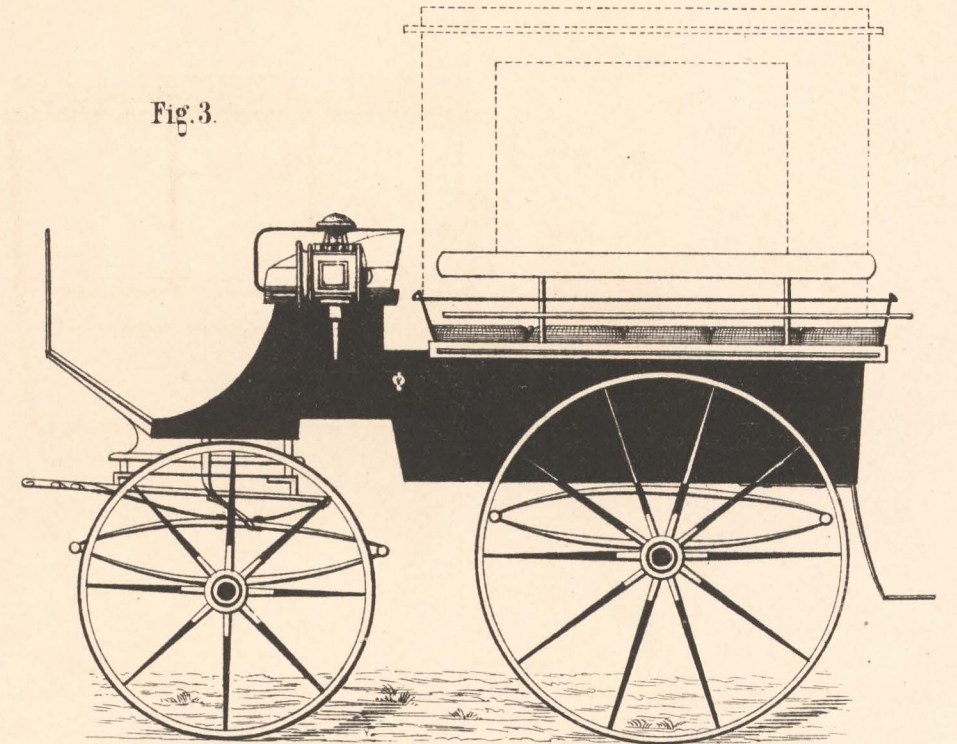


Fig. 4.

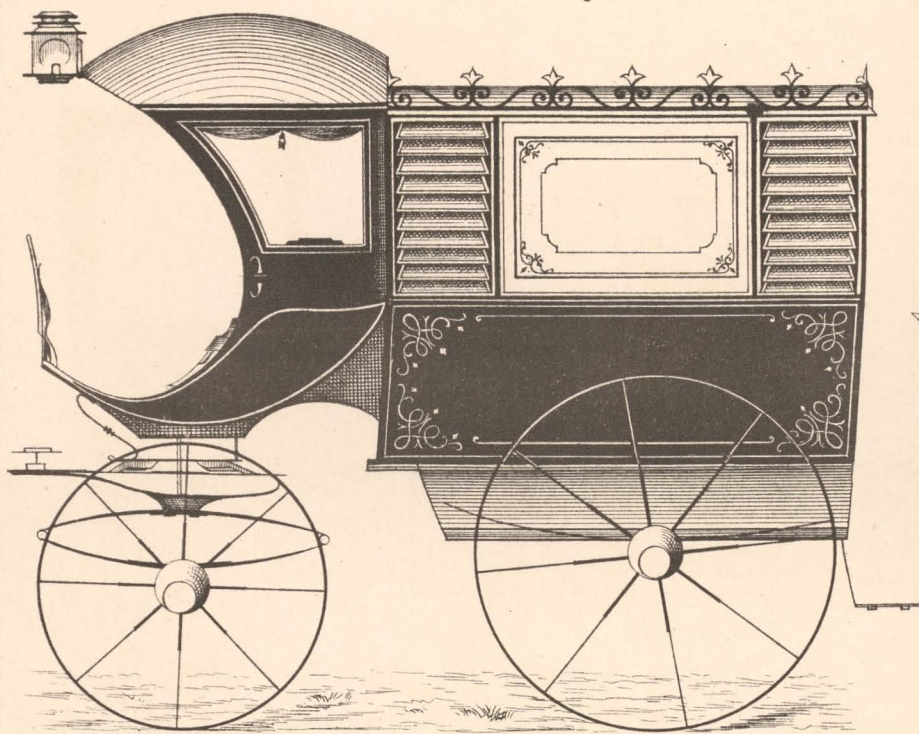


Fig. 5.

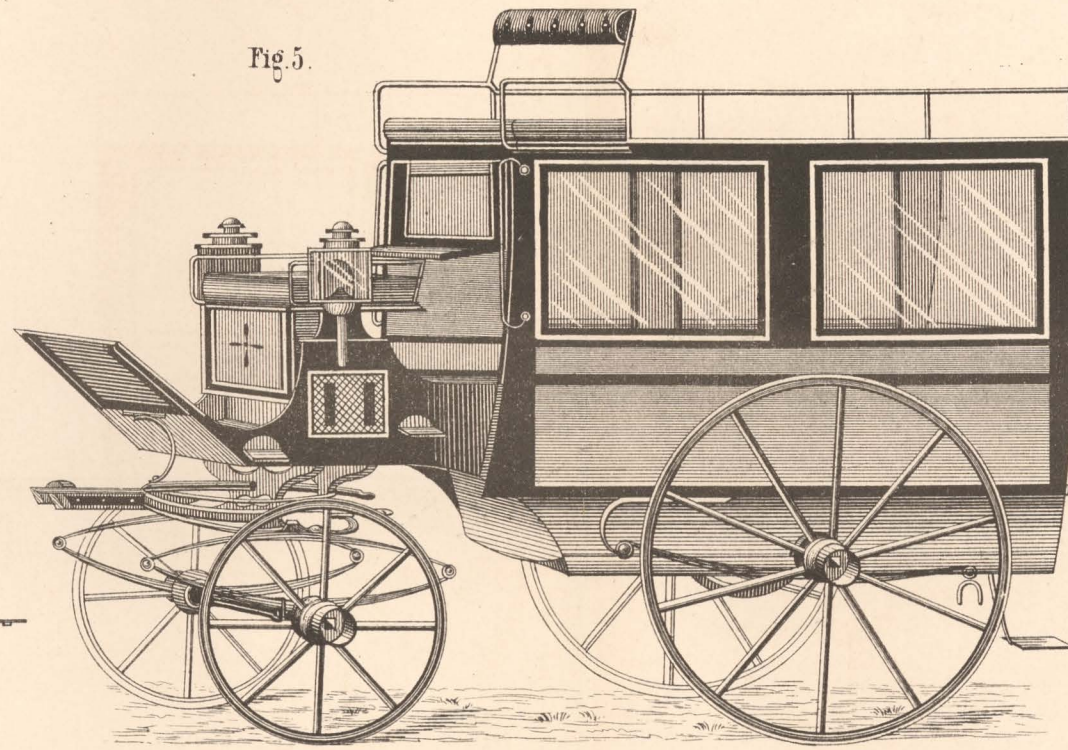
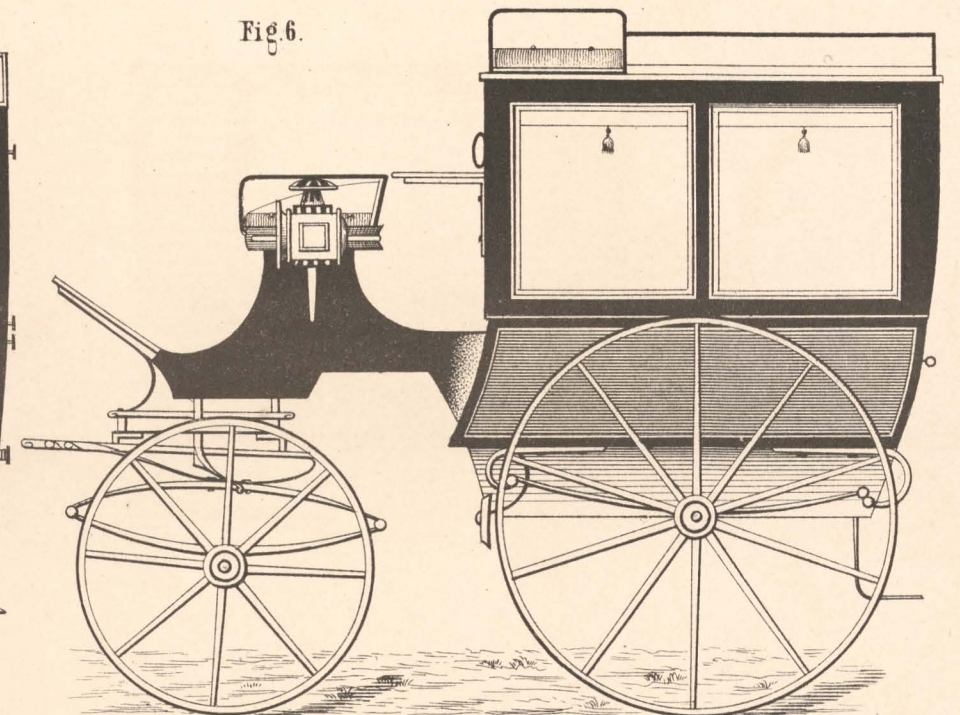


Fig. 6.



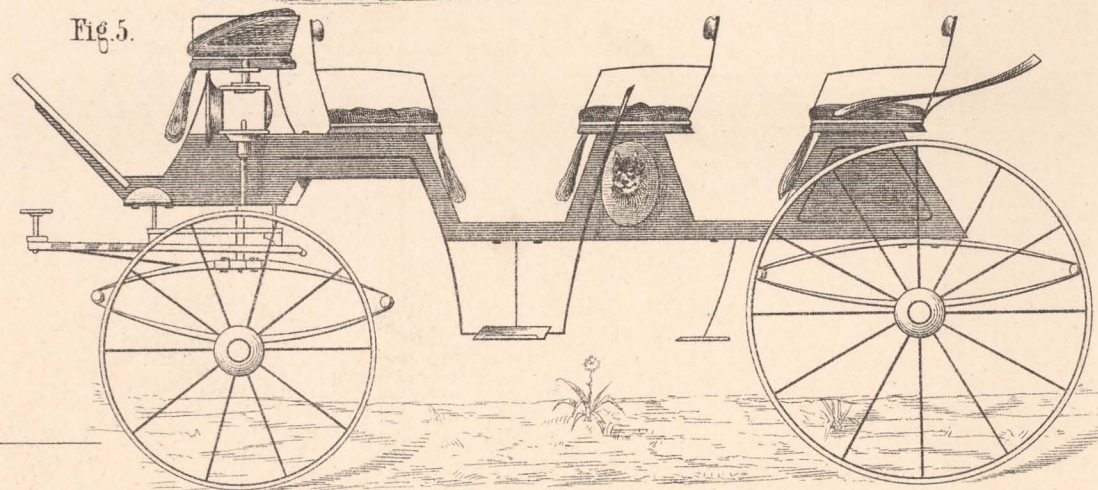
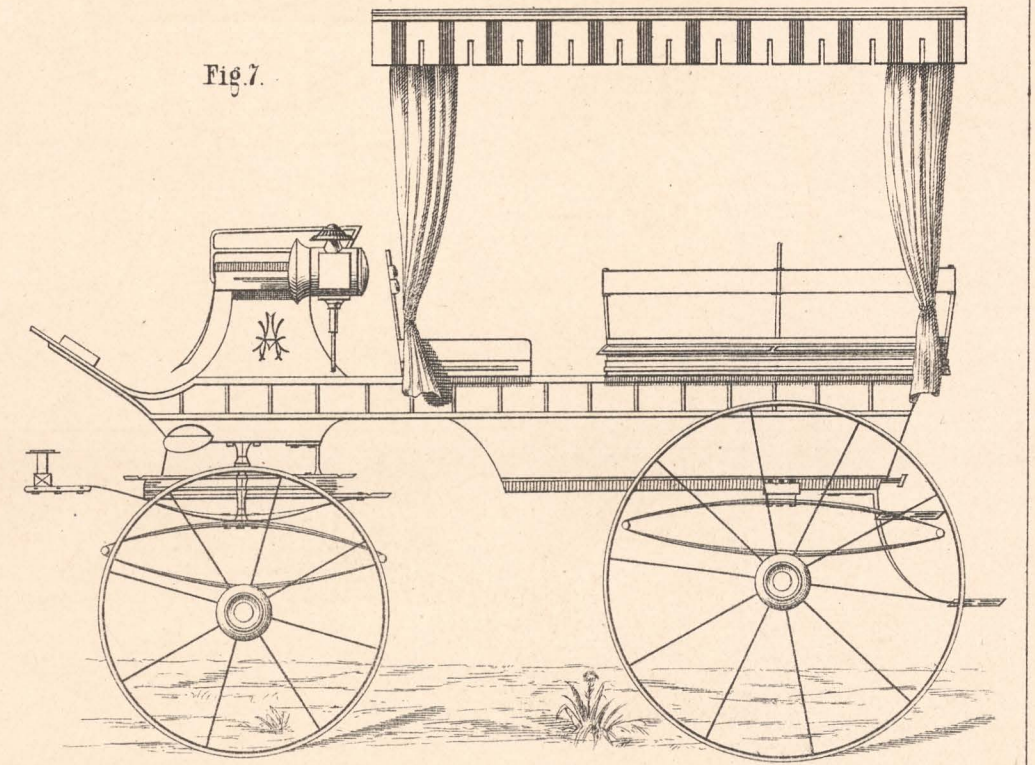
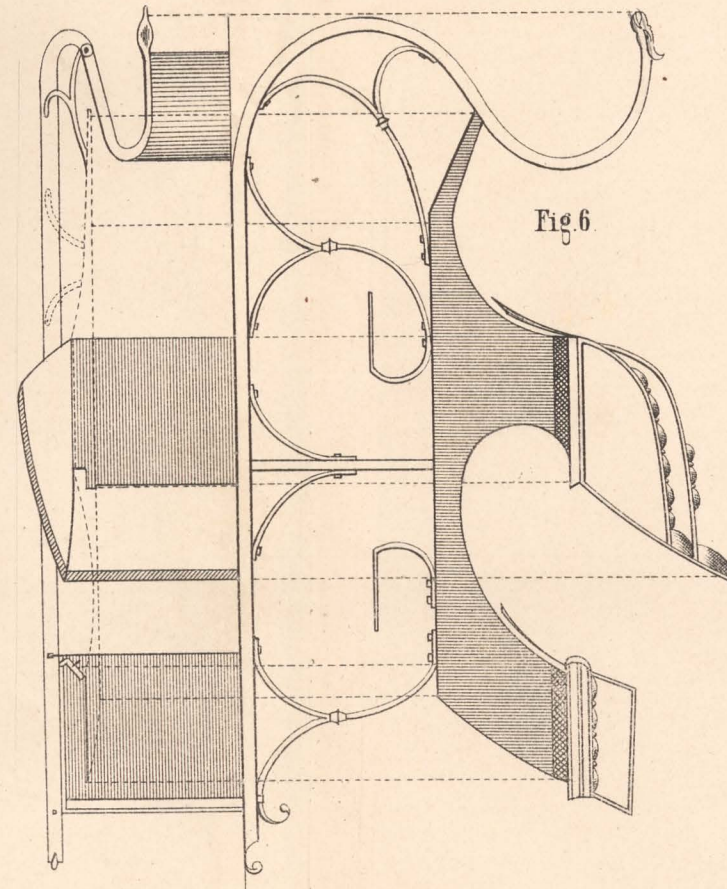
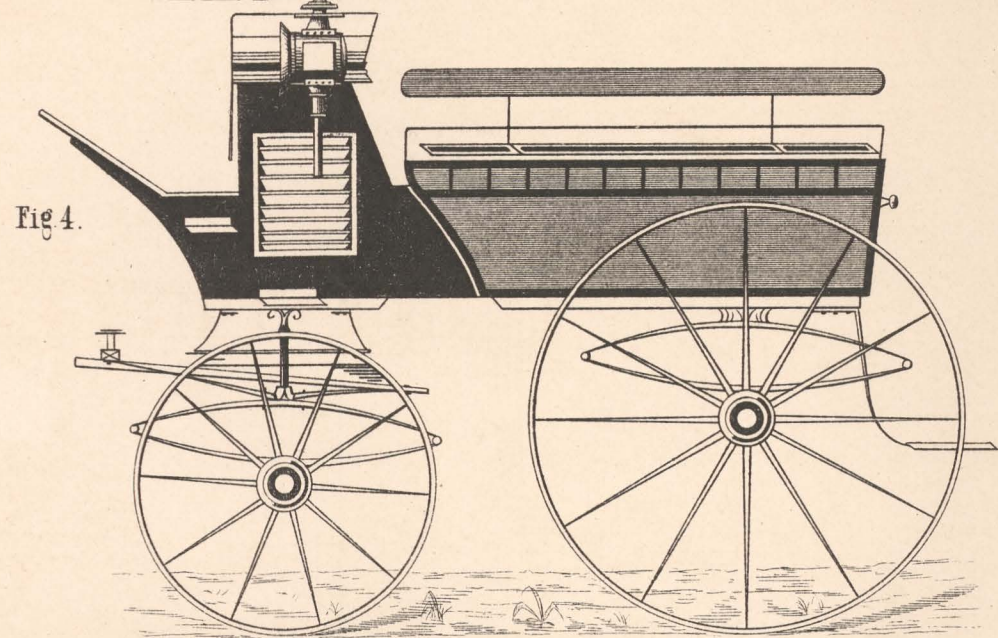
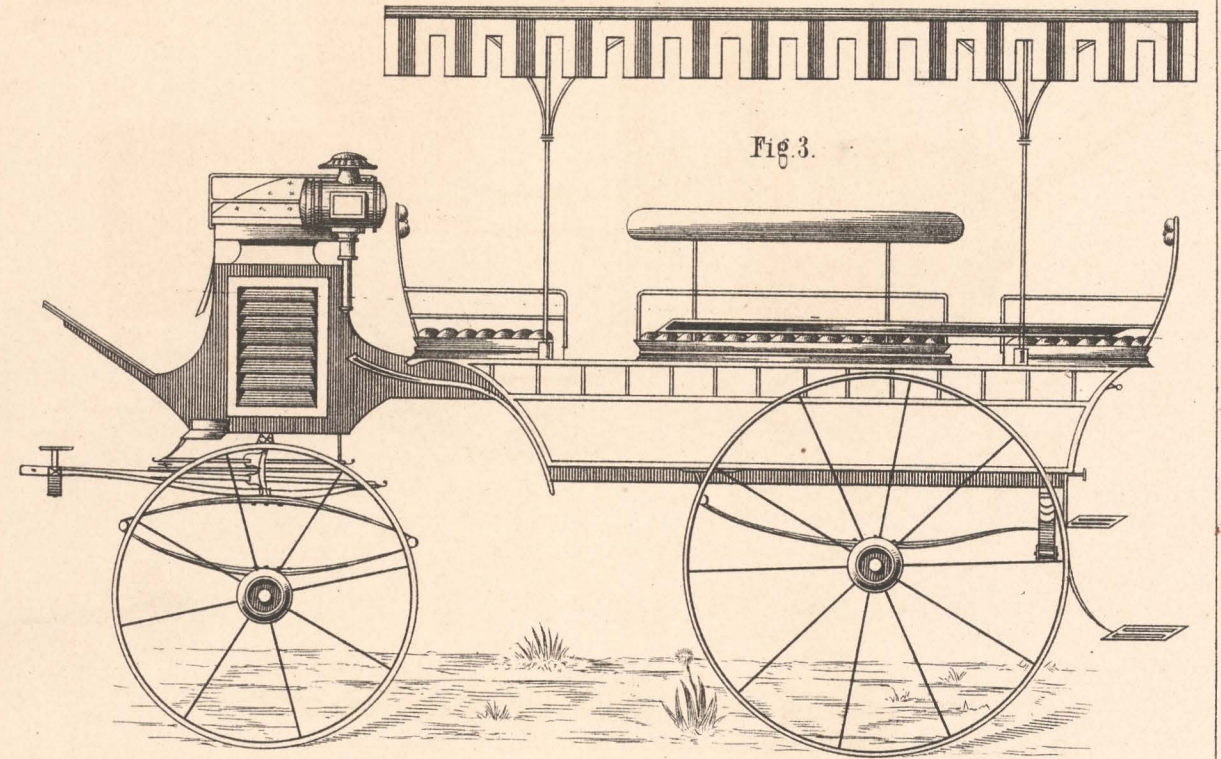
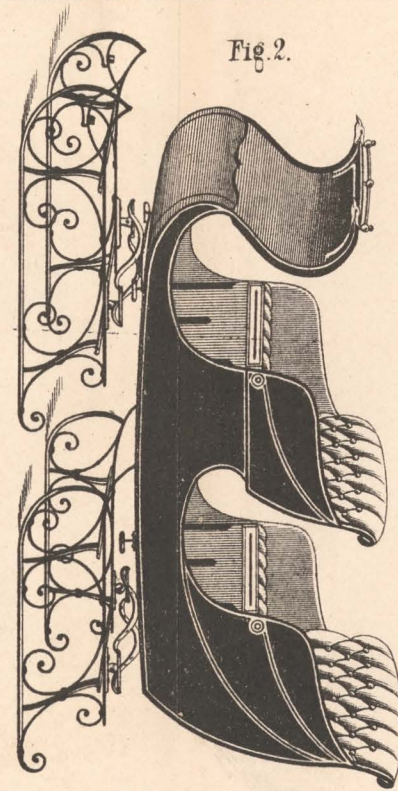
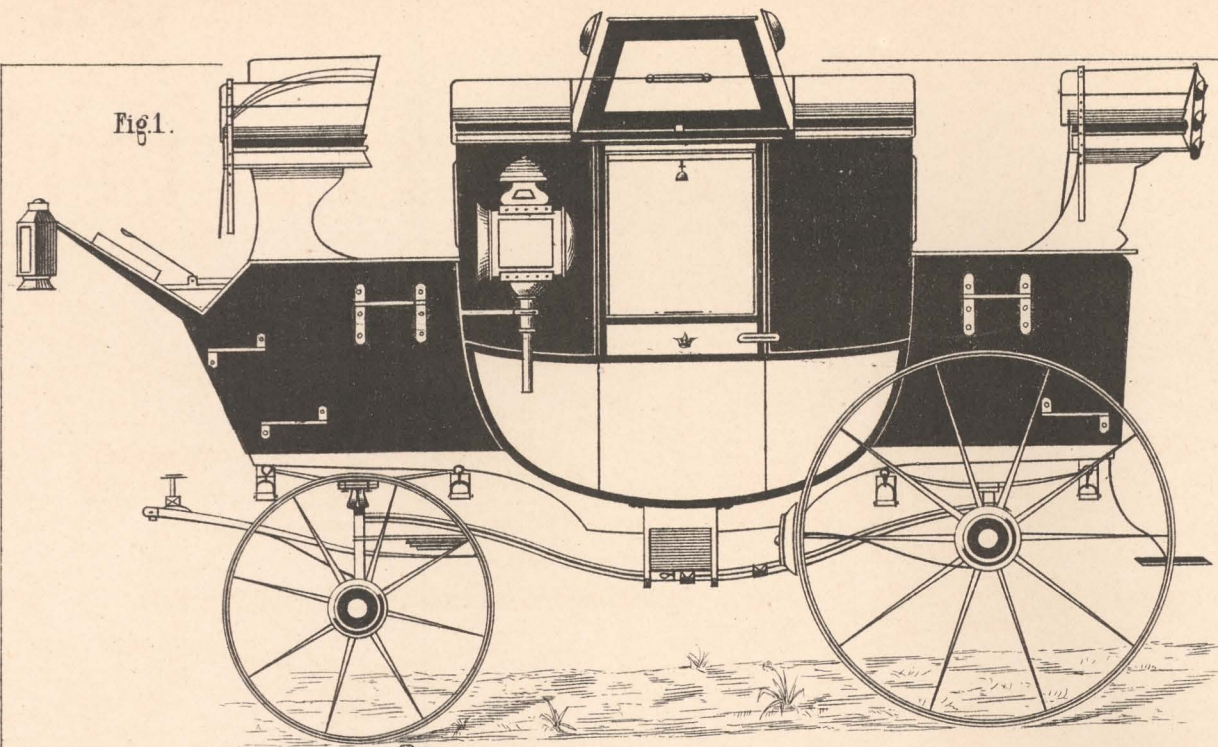


Fig. 1.

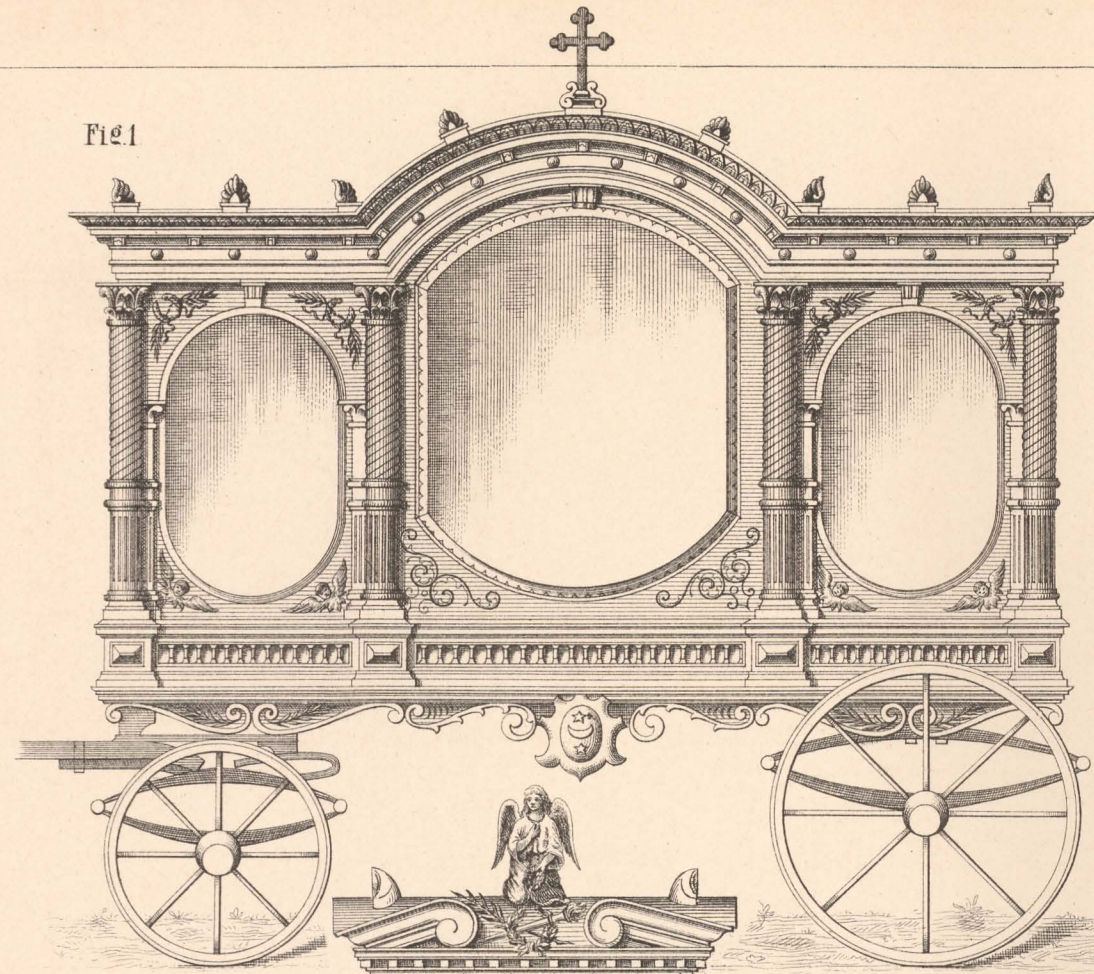


Fig. 2.

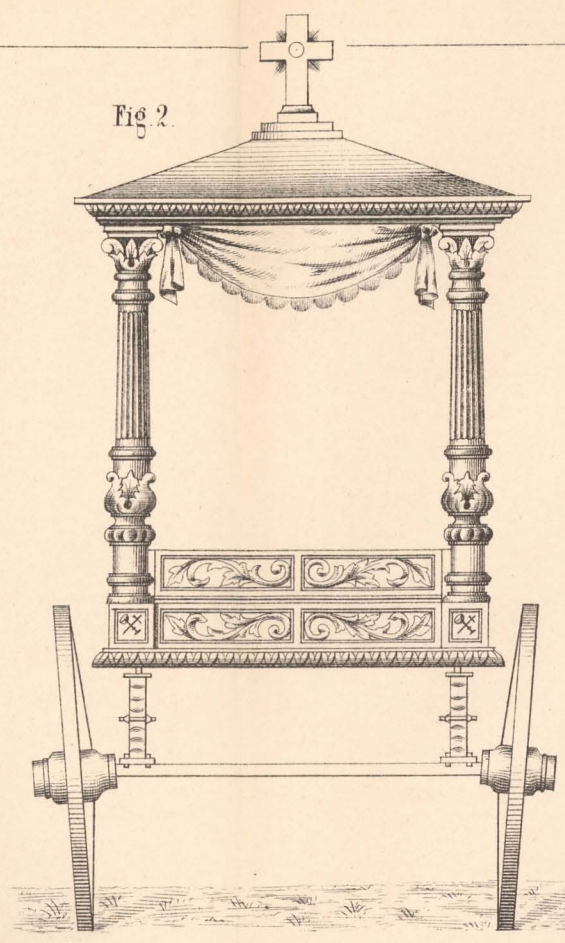


Fig. 3.

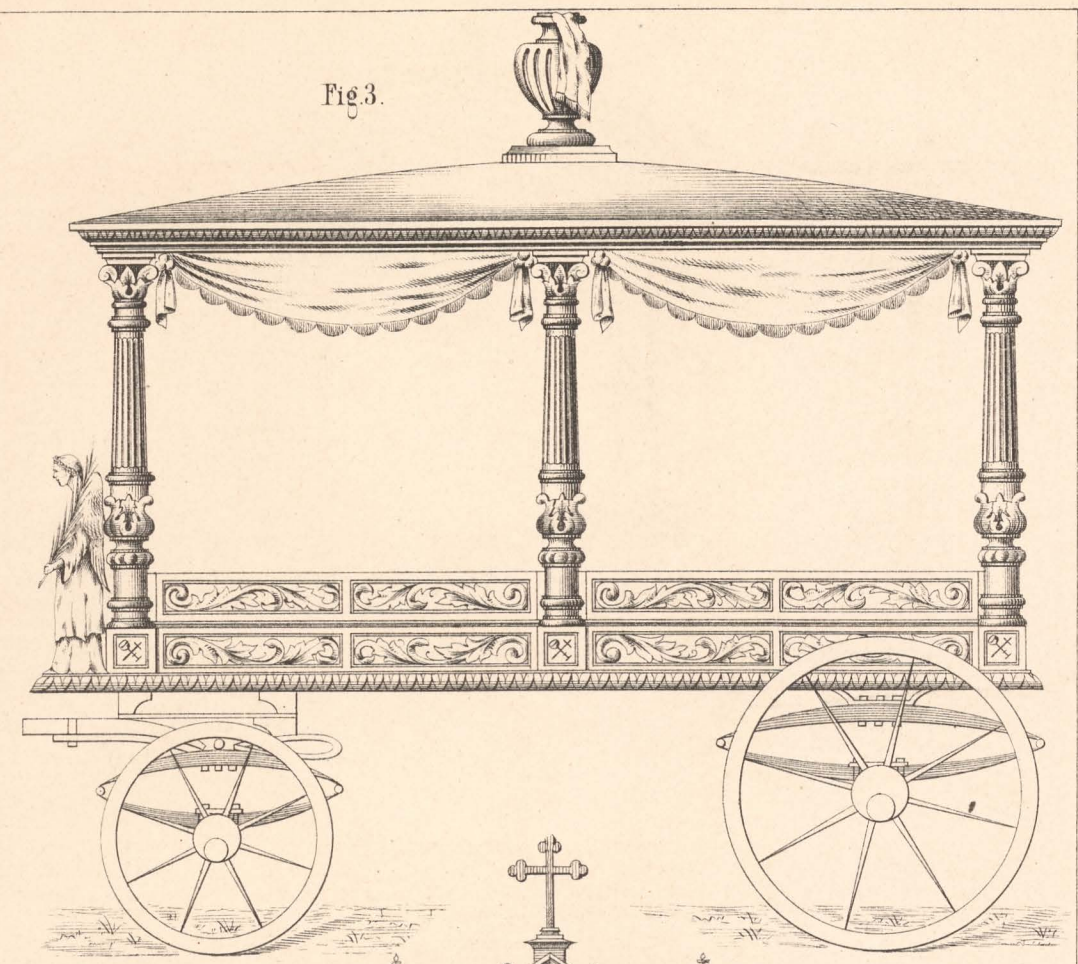


Fig. 4.

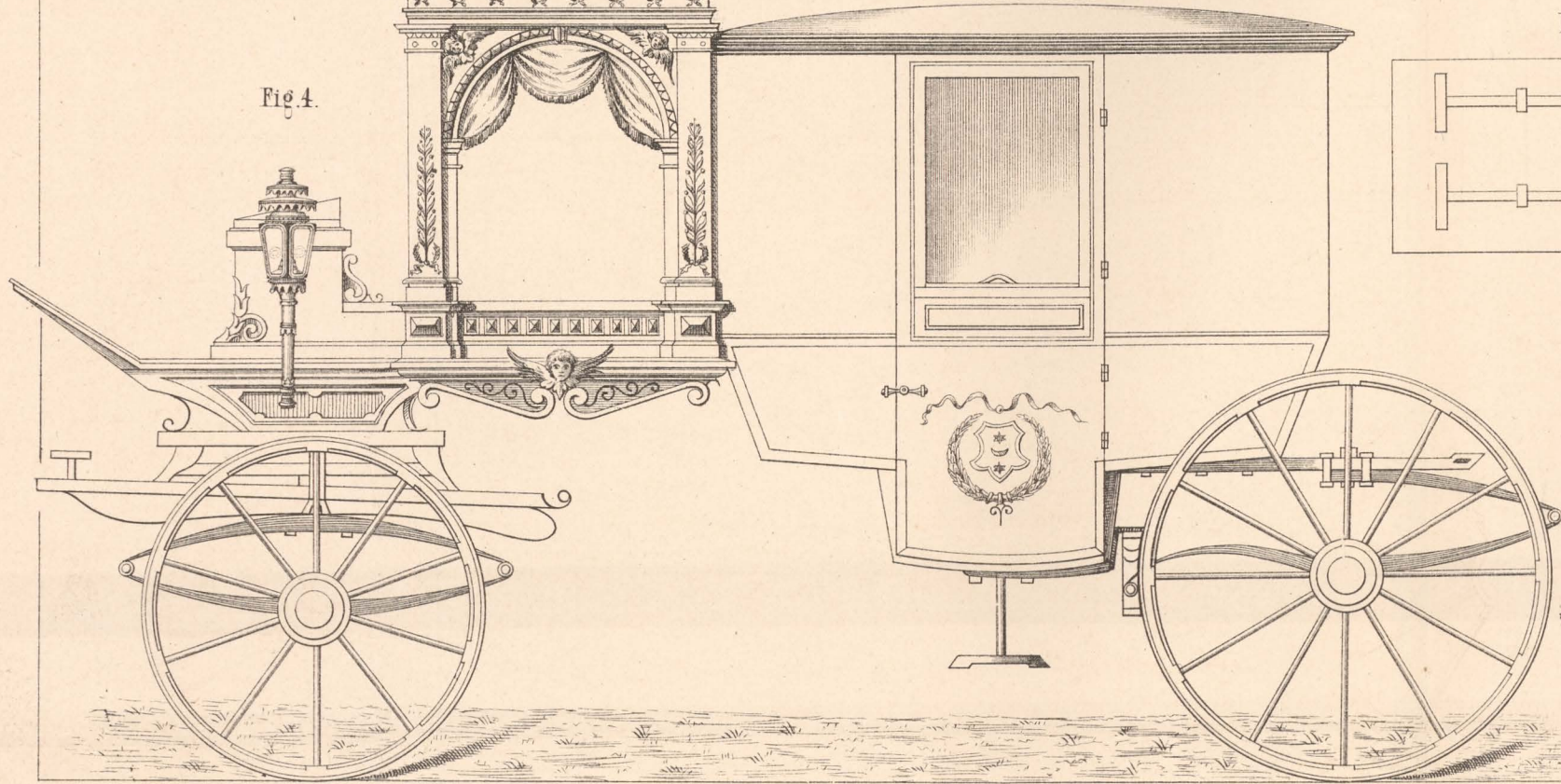


Fig. 5.

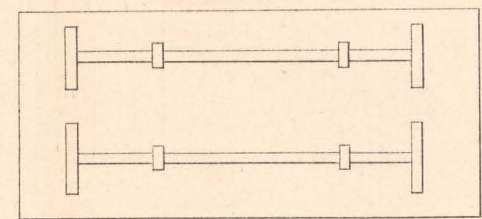


Fig. 6.

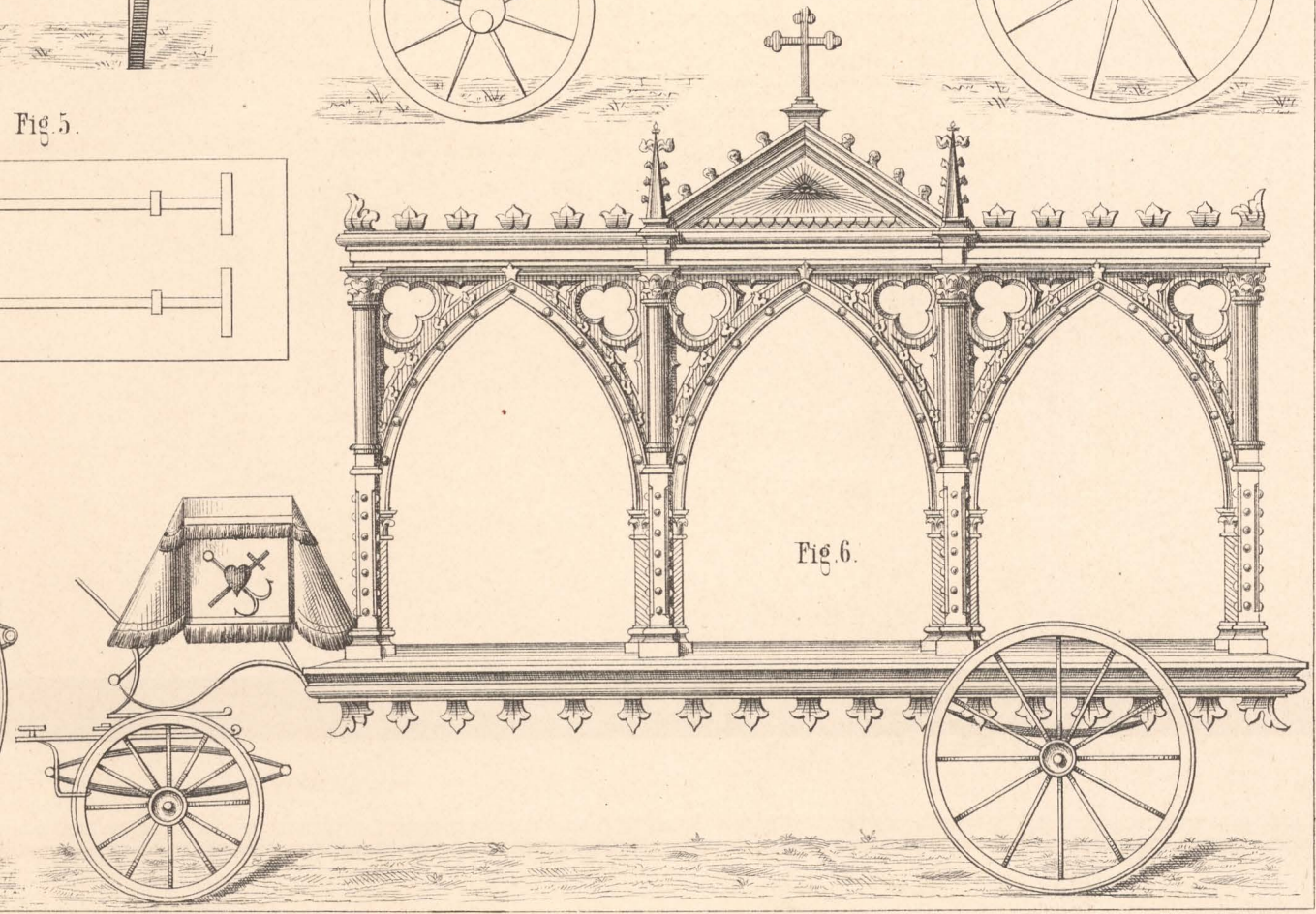


Fig. 1.

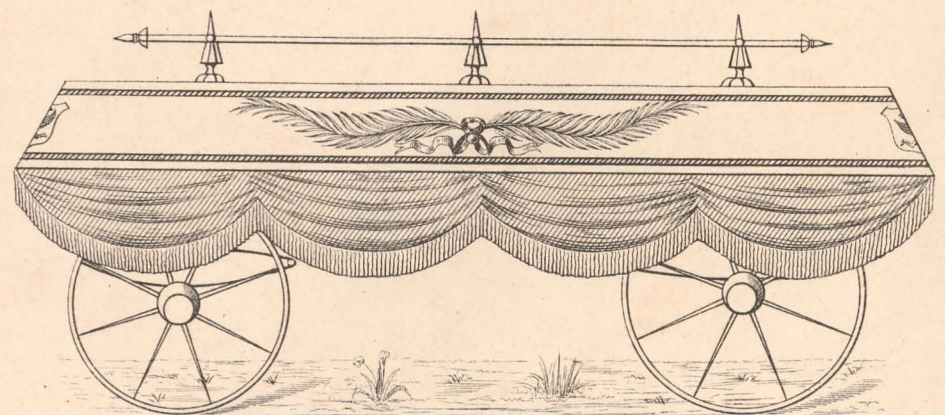


Fig. 2.

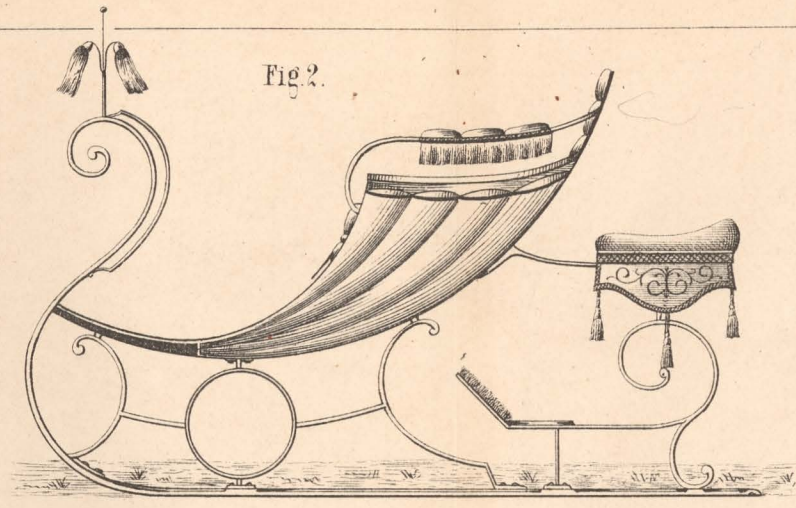


Fig. 3.

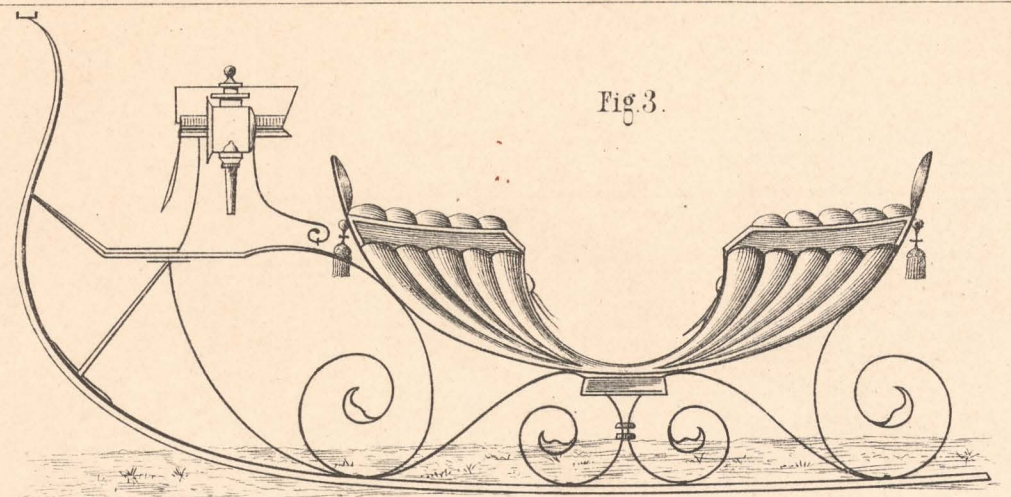


Fig. 4.

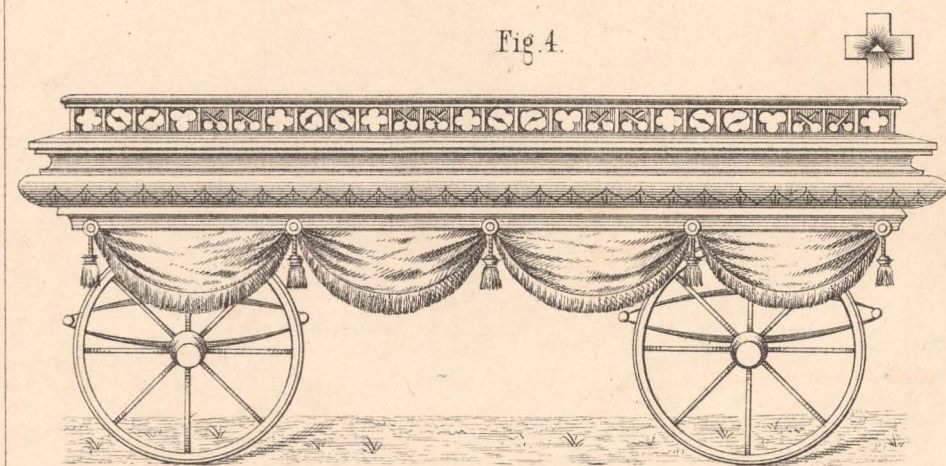


Fig. 5.

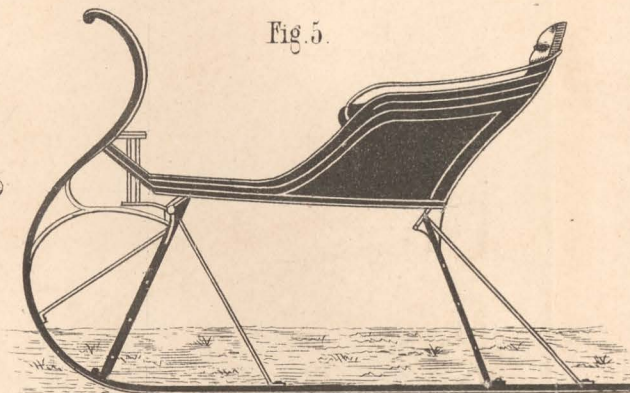


Fig. 6.

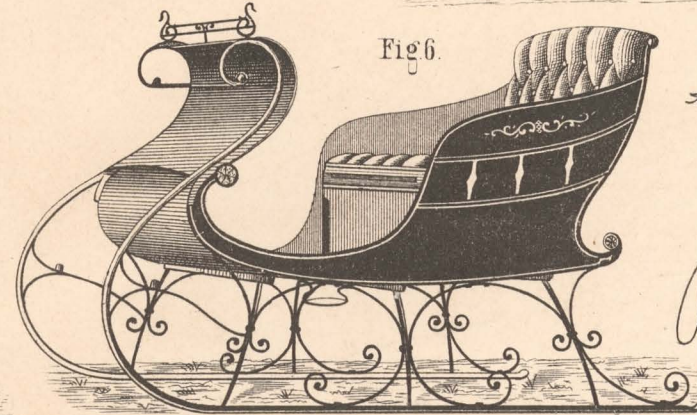


Fig. 7.

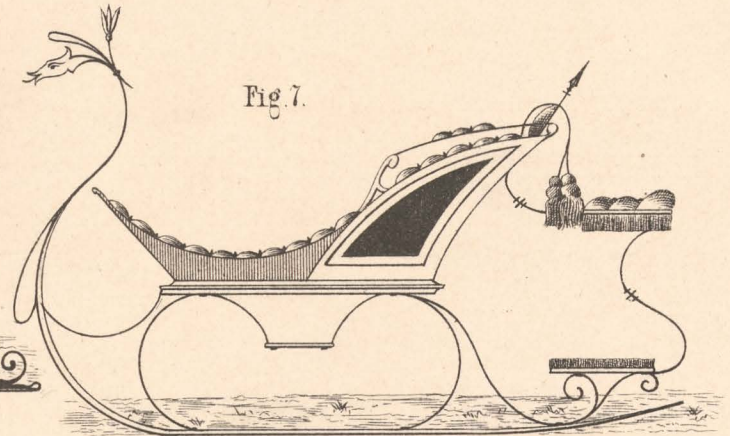


Fig. 9.

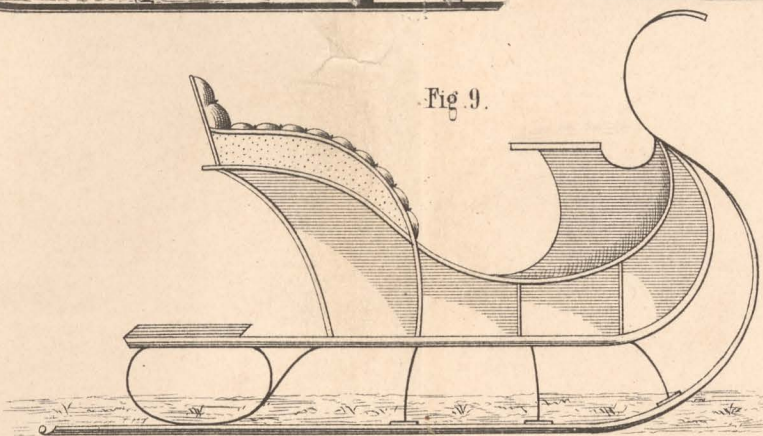


Fig. 10.

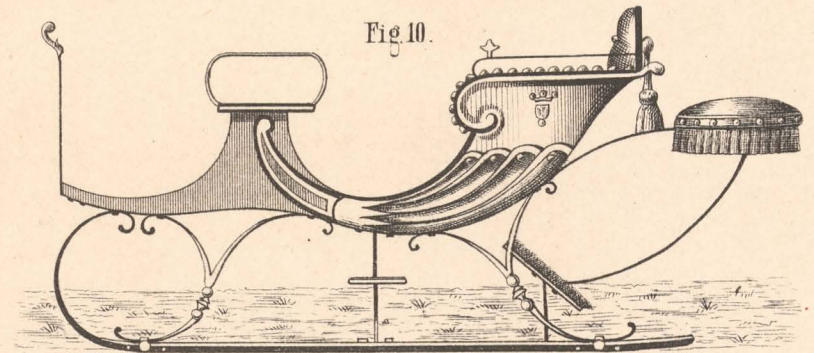


Fig. 8.

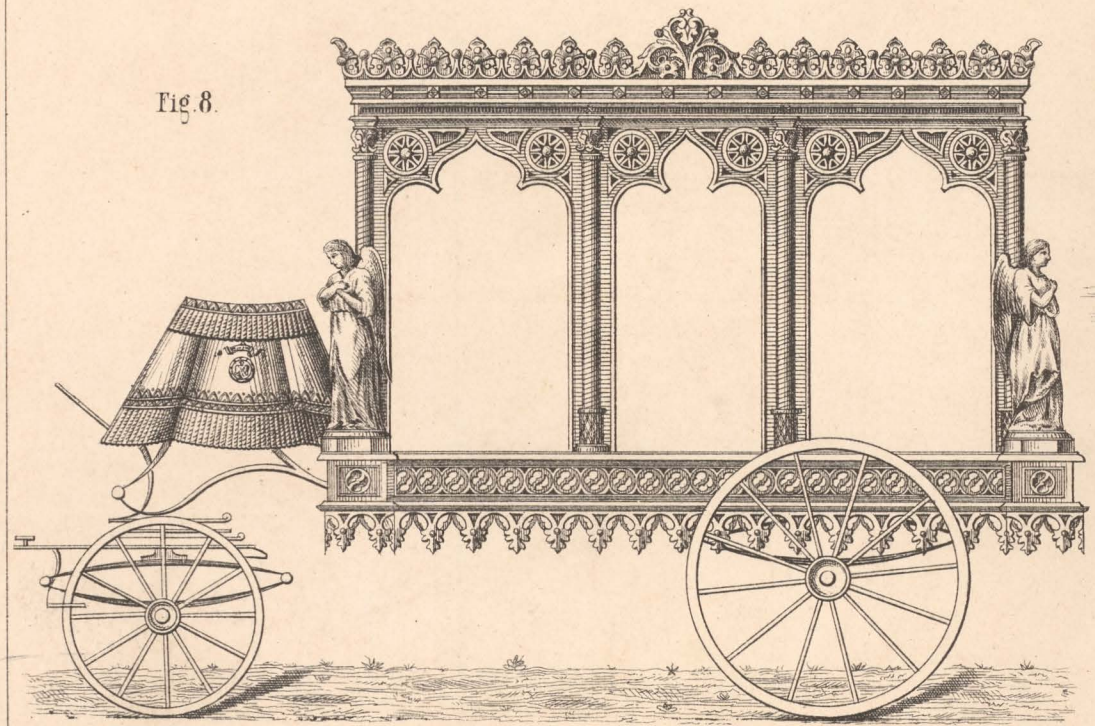


Fig. 11.

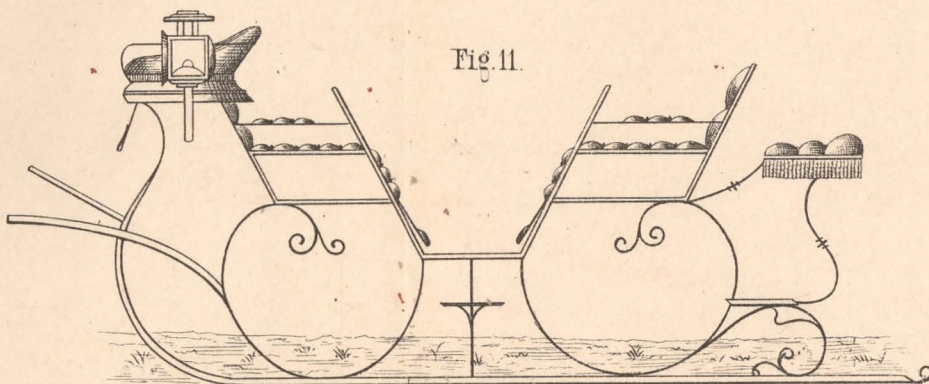
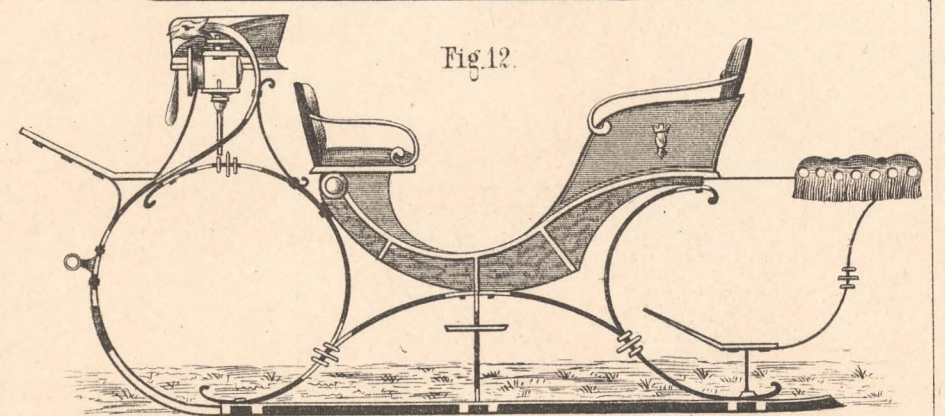


Fig. 12.



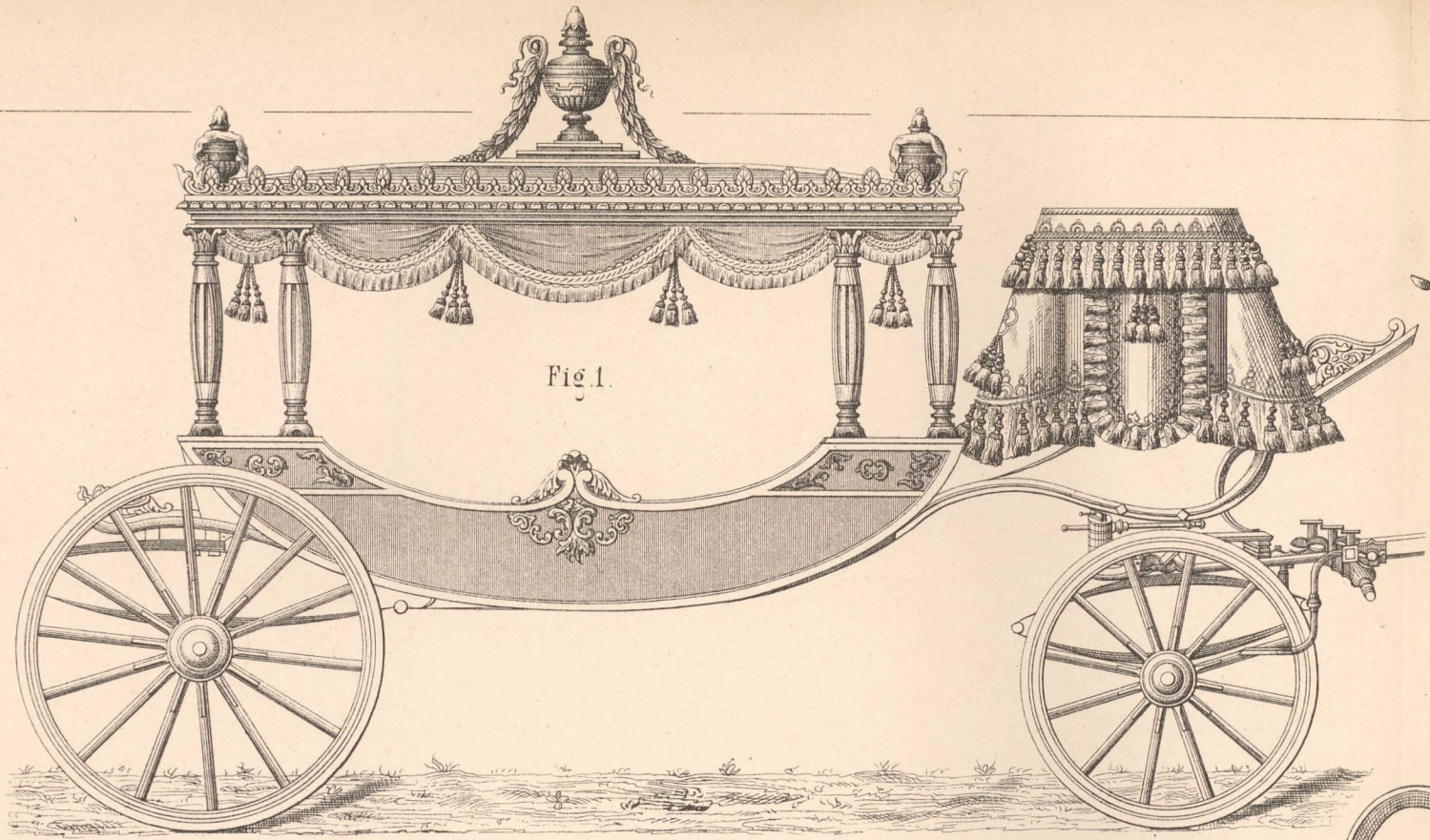


Fig. 1.

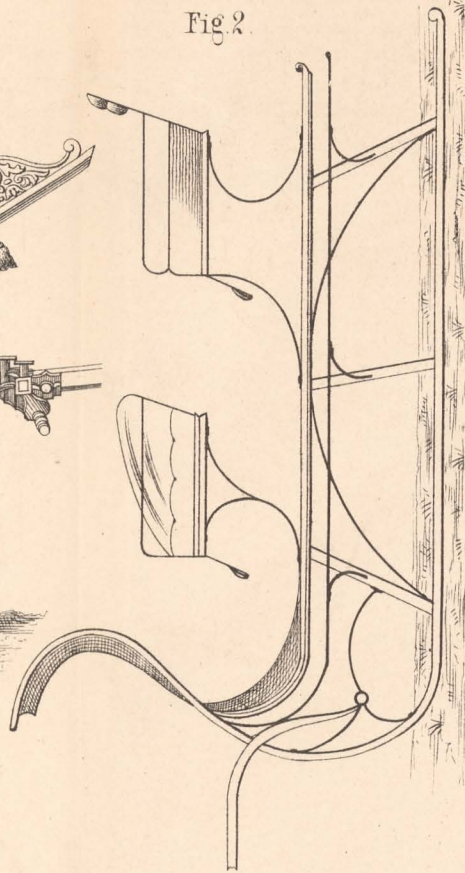


Fig. 2.

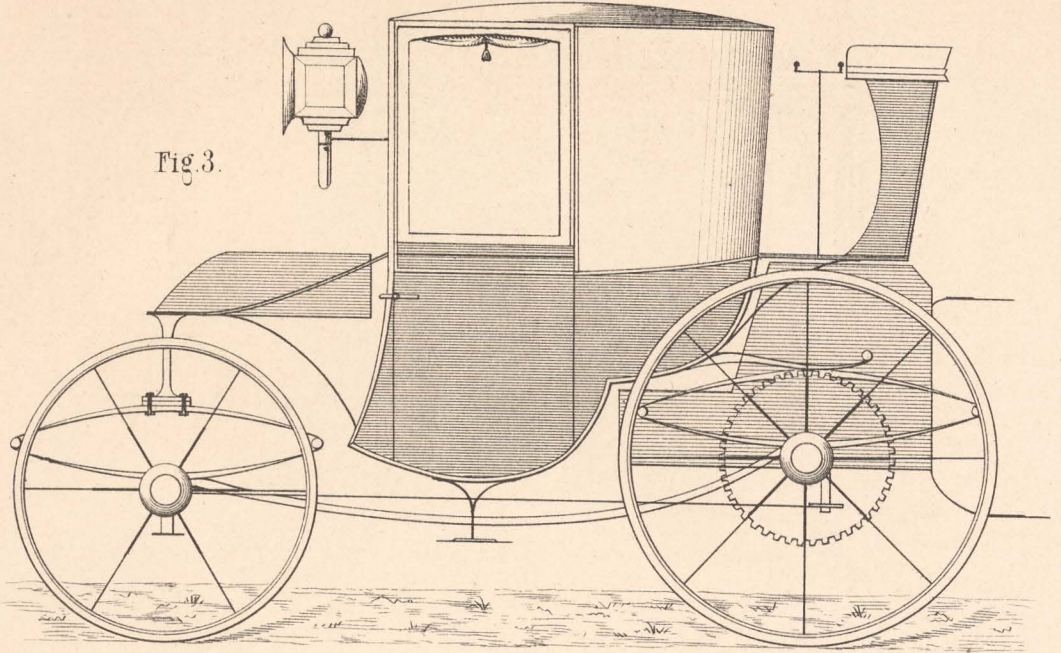


Fig. 3.

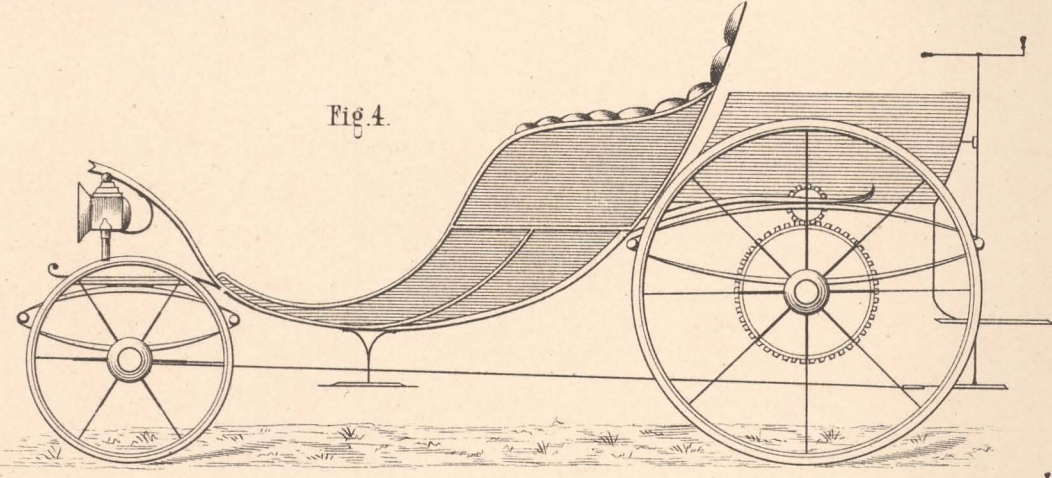


Fig. 4.

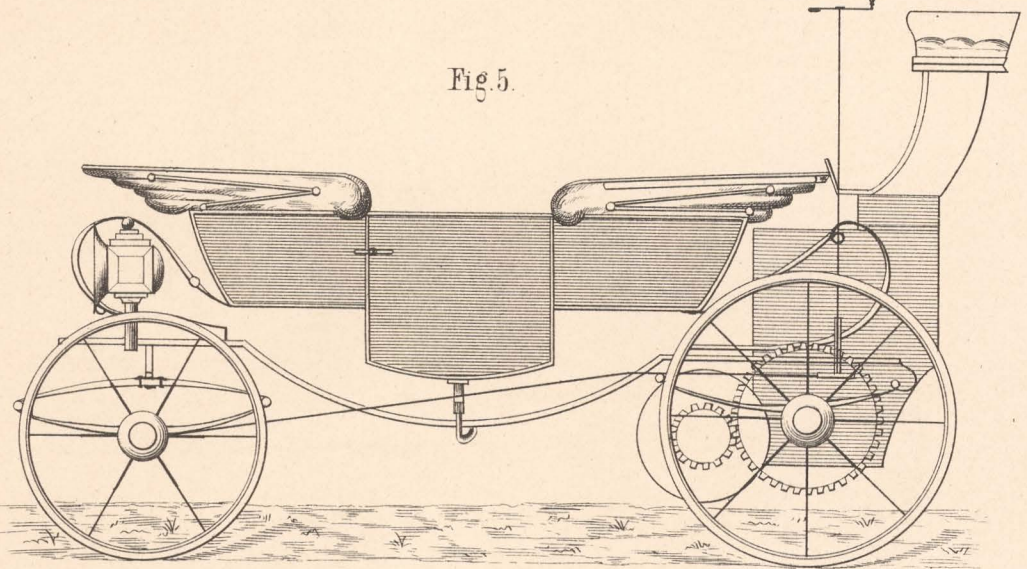


Fig. 5.

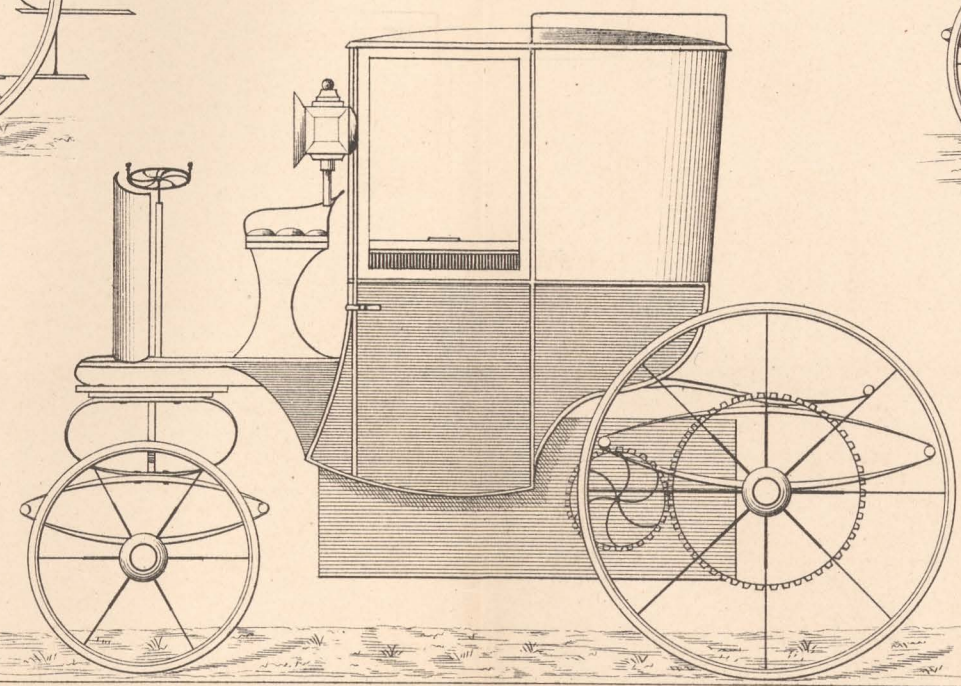


Fig. 7.

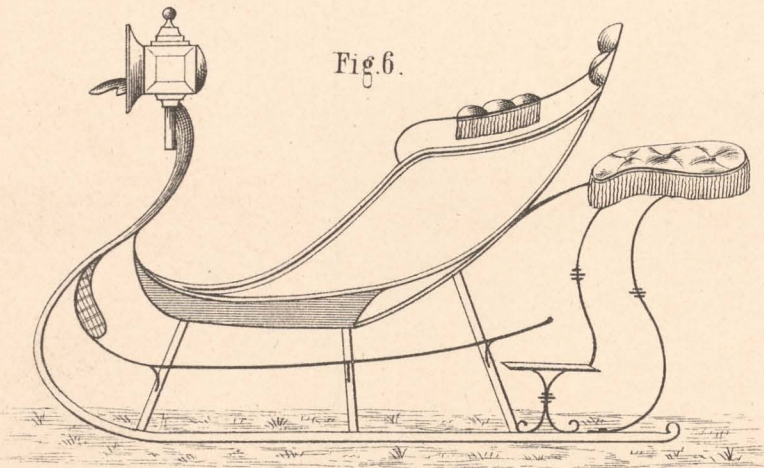


Fig. 6.

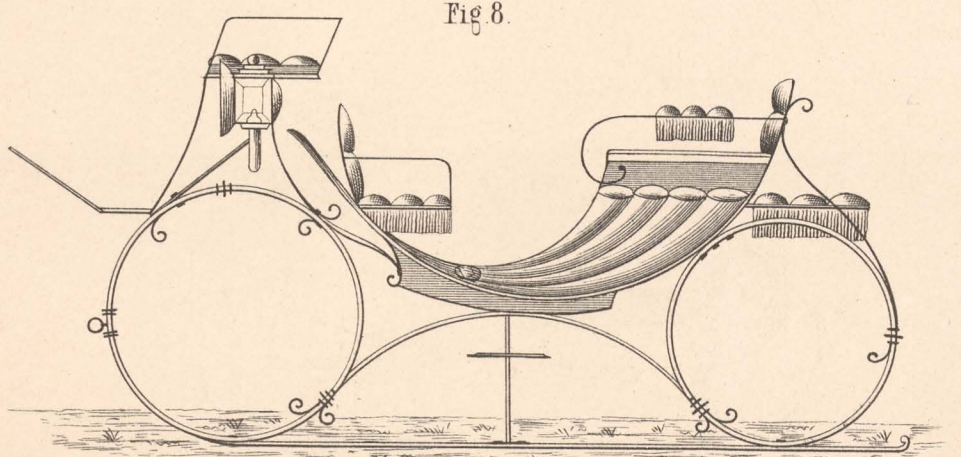


Fig. 8.



