

I RARA-SLG
4185 *Tafelvol. 2.*

Kupfertafeln

zum

Compendium

der populären

Mechanik und Maschinenlehre

von

Adam Burg.

Zweite verbesserte und vermehrte Auflage.

Wien 1848.

Verlag von Carl Gerold.



Bibliothek



Technischen Hochschule

Graz.

No. 4185

F. 8°

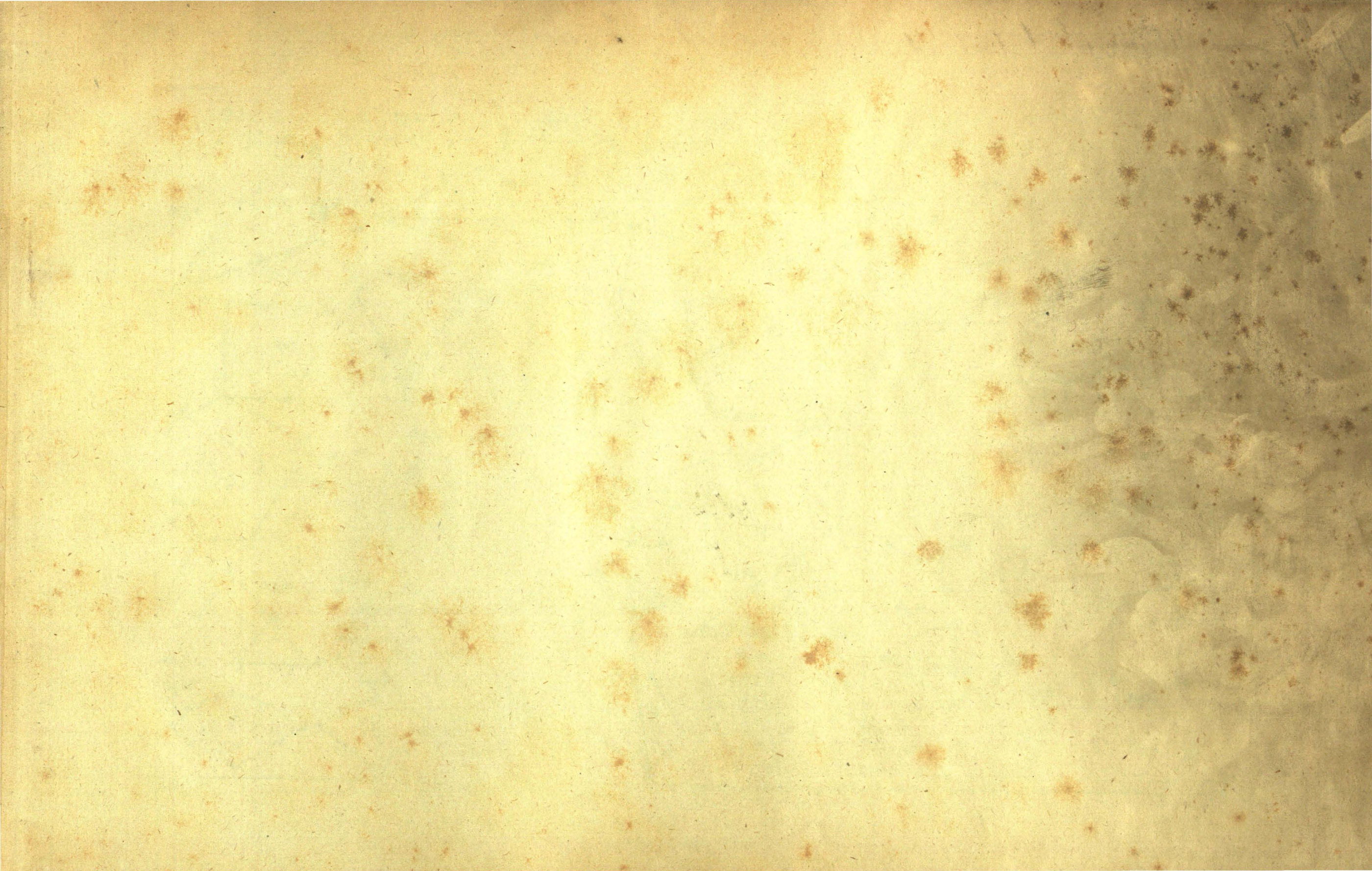

Burg's Mechanik.

Taf. 1. Fig. 1-34.

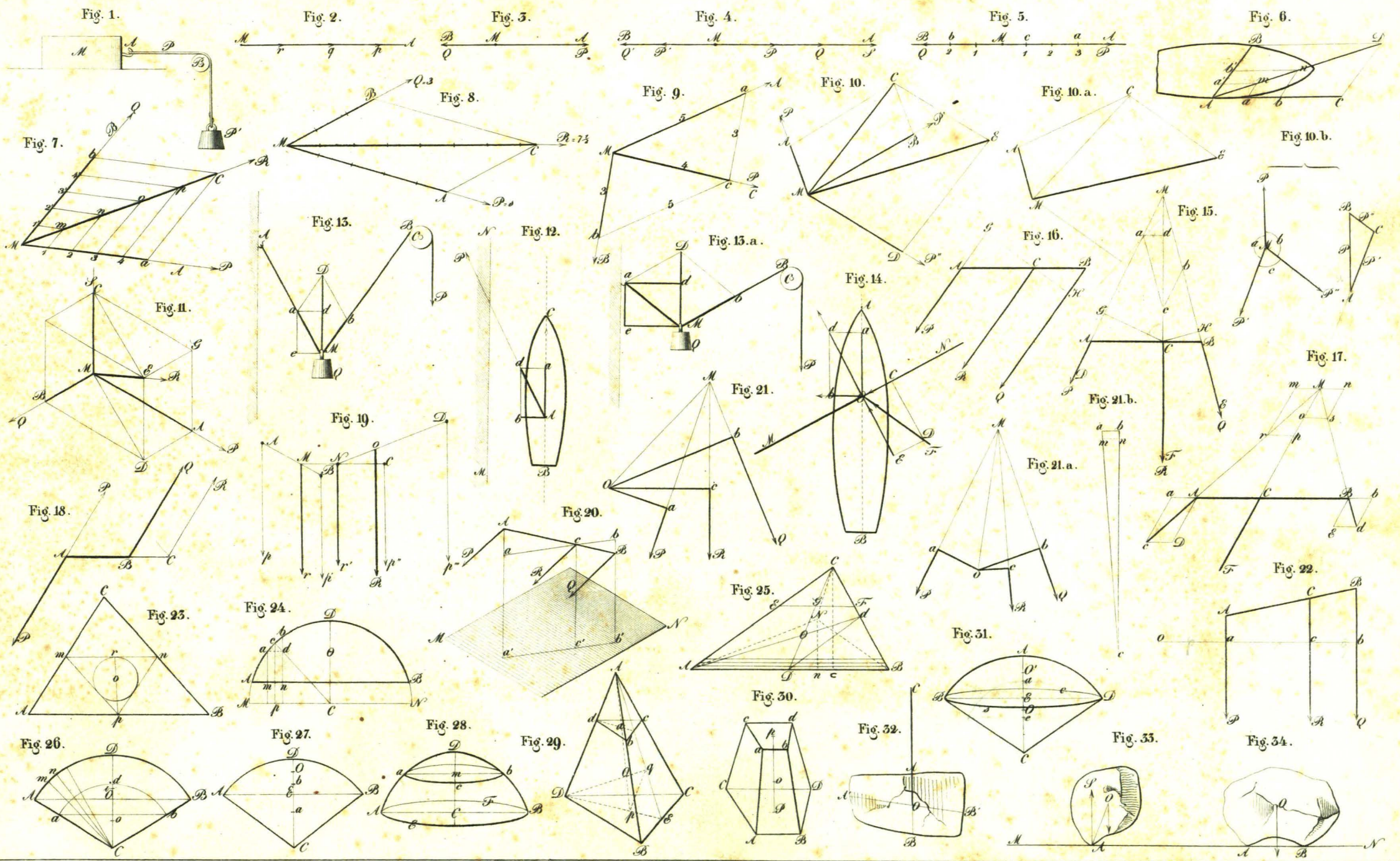

W. Engerth. del.

M. Aigner sc.

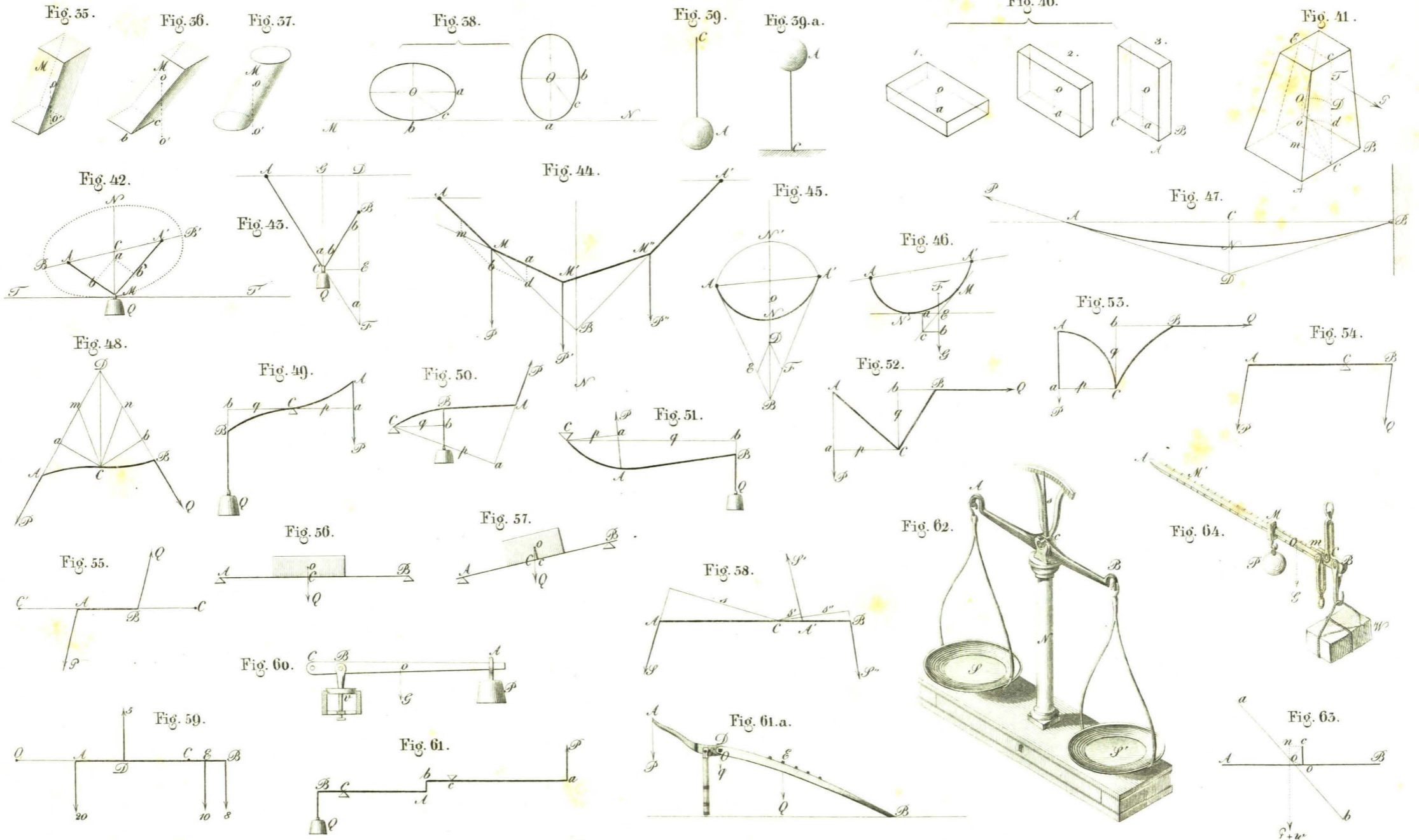

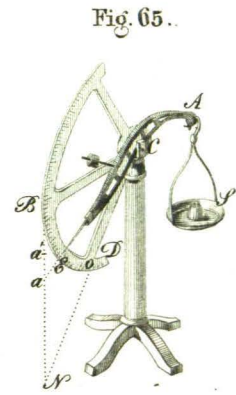

Fig. 65.

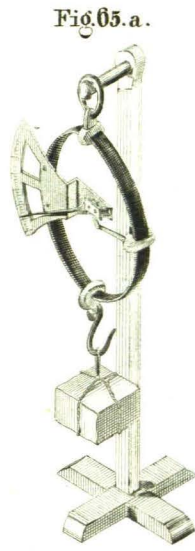

Fig. 65.a.

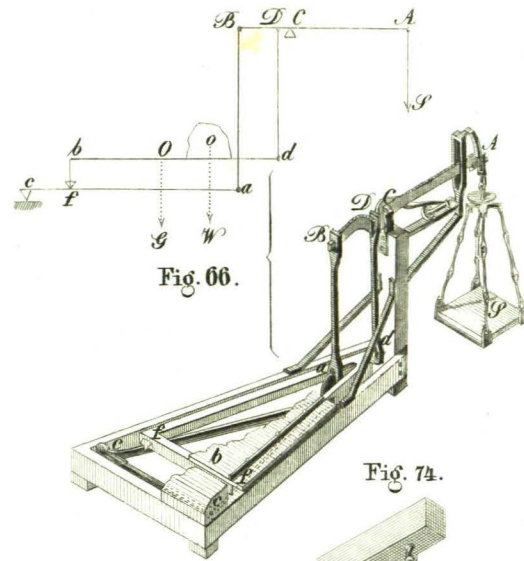

Fig. 66.

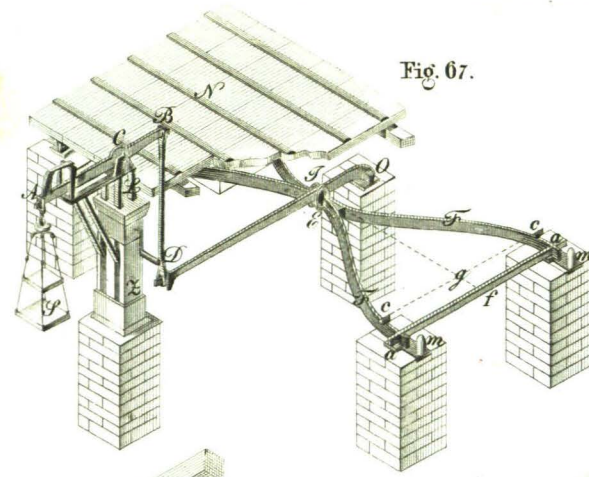

Fig. 67.

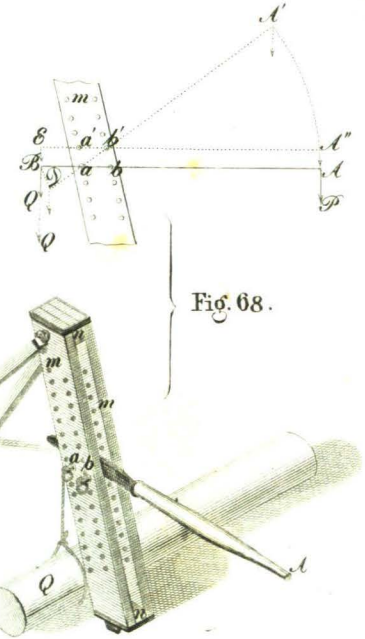

Fig. 68.

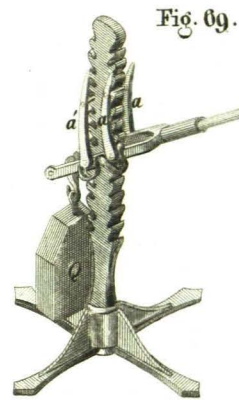

Fig. 69.

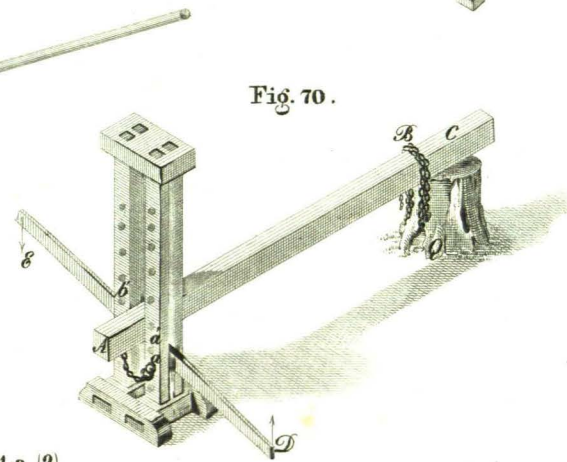

Fig. 70.

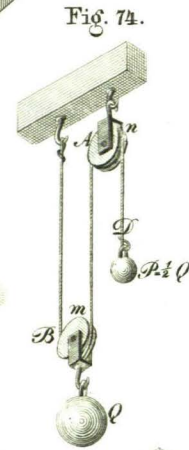

Fig. 71.

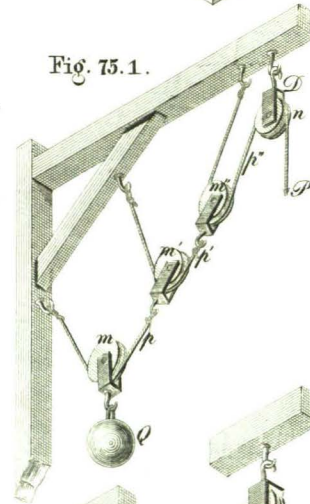

Fig. 75.1.

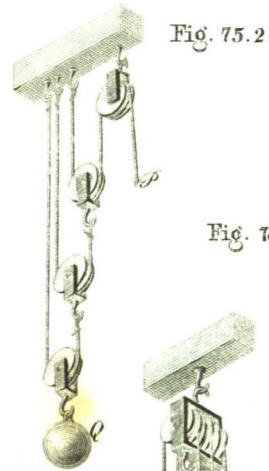

Fig. 75.2.



Fig. 71.1.



Fig. 71.a.(2).

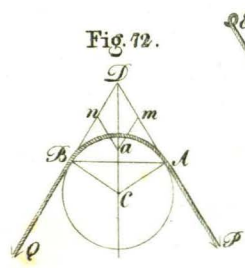

Fig. 72.

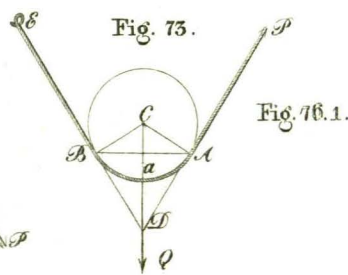

Fig. 73.

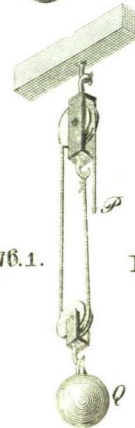

Fig. 76.1.



Fig. 76.2.



Fig. 76.3.

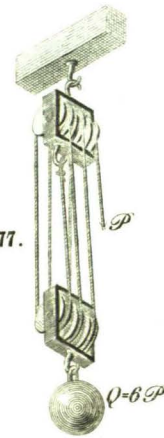

Fig. 77.



Fig. 78.

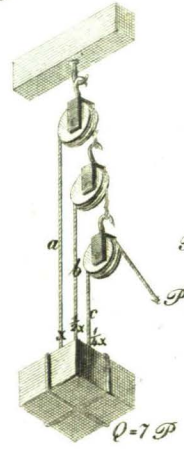

Fig. 79.

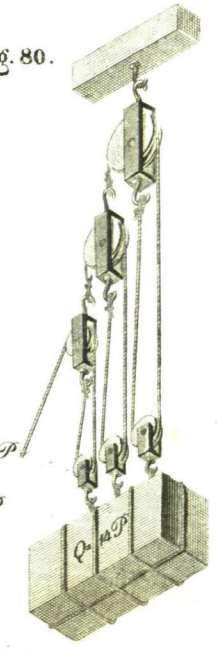
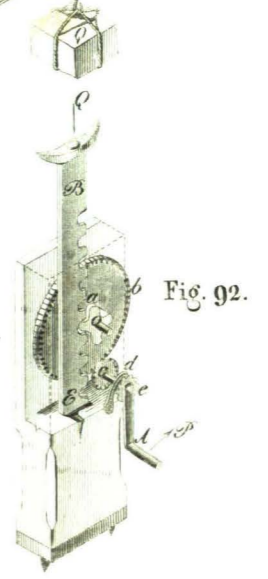
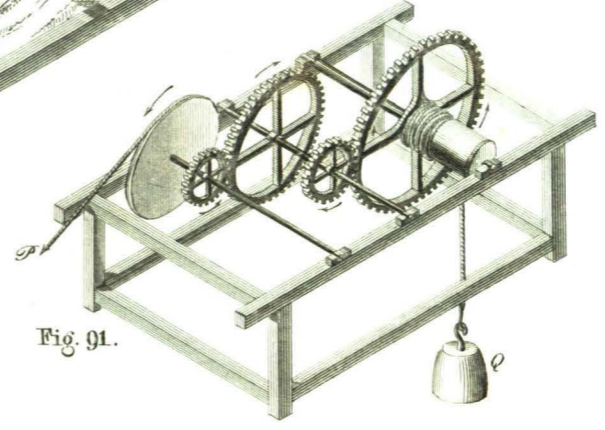
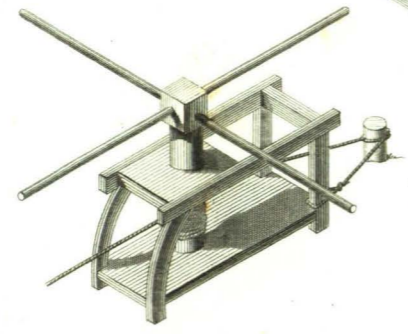
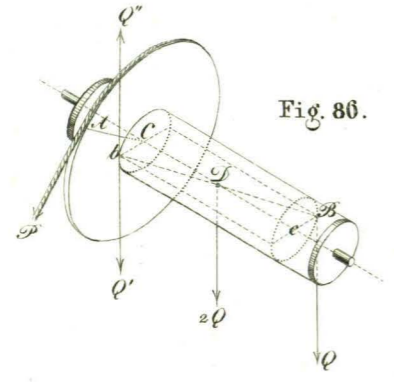
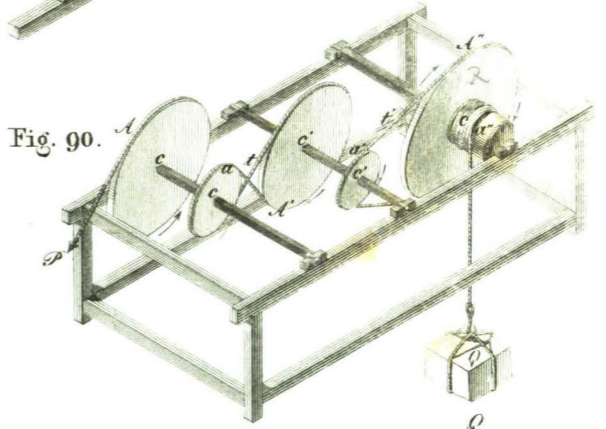
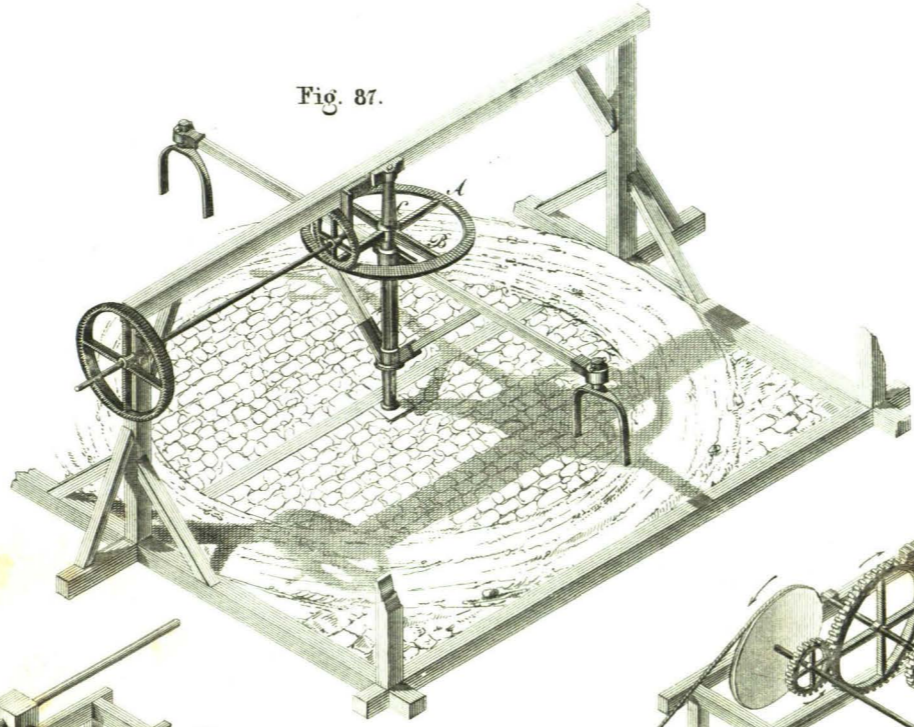
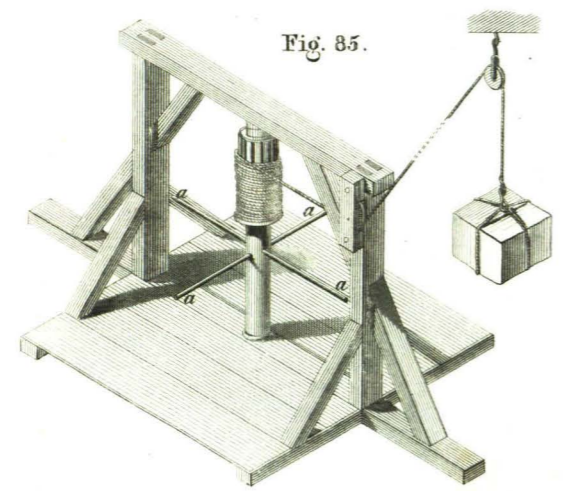
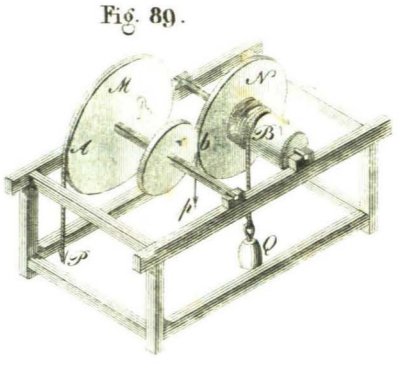
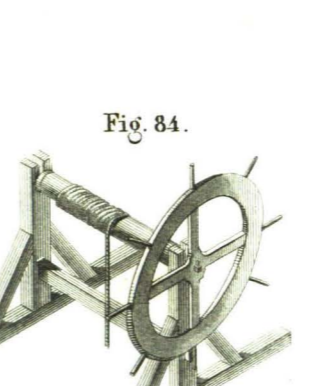
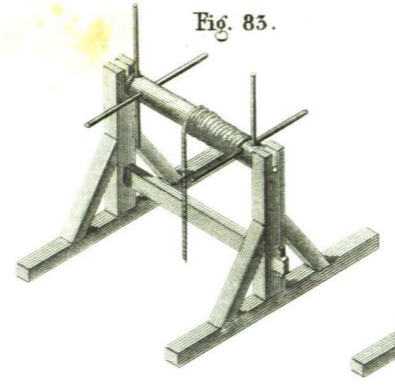
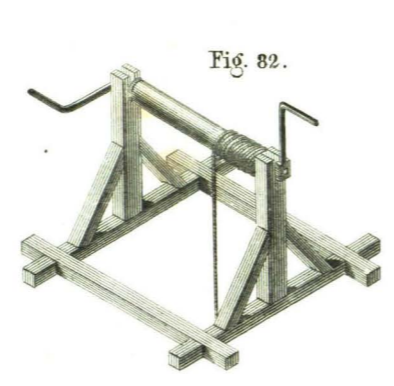
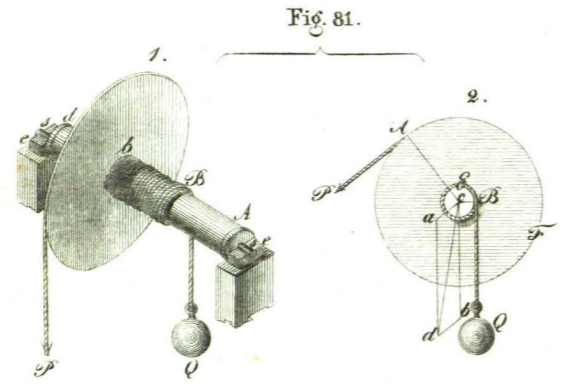
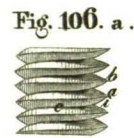
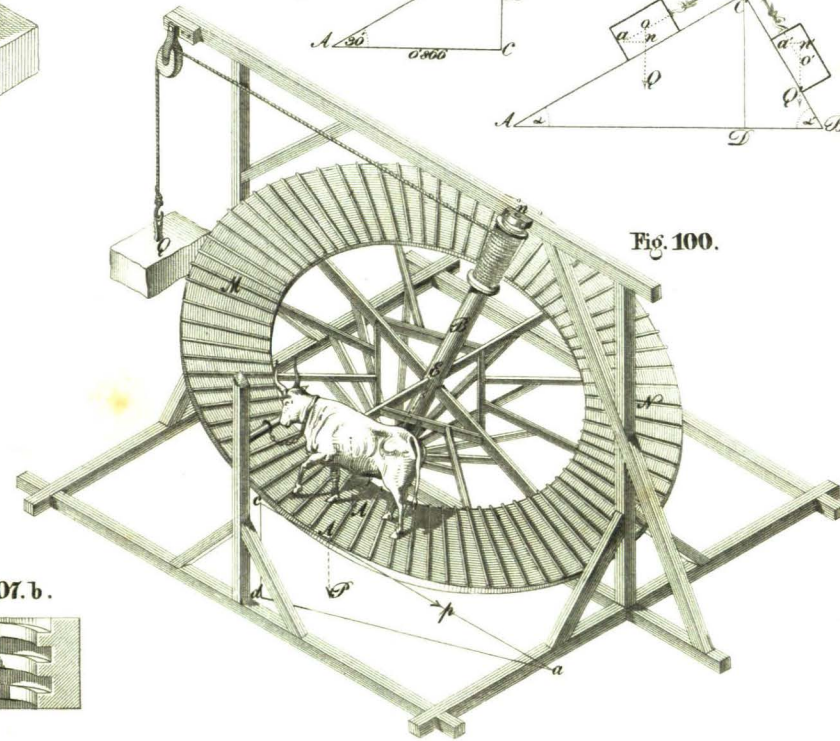
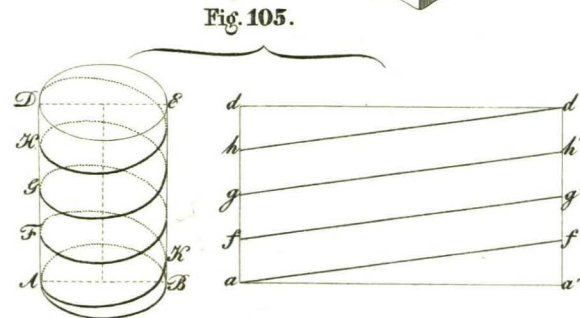
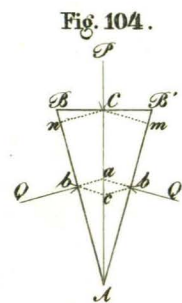
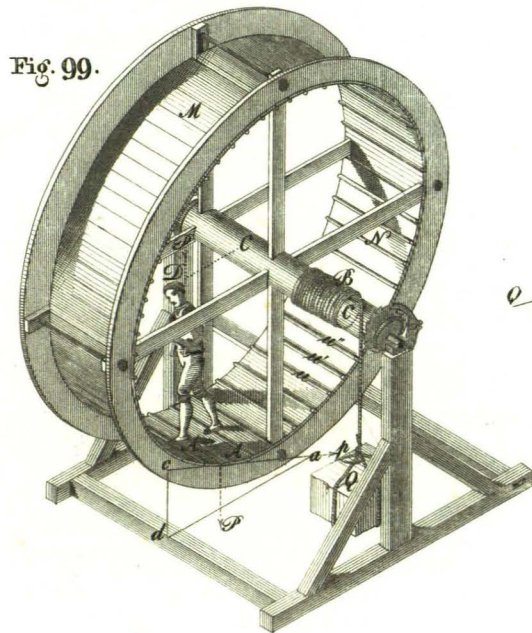
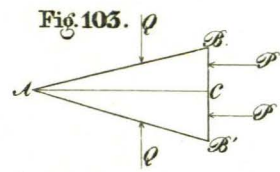
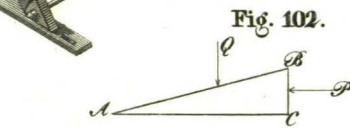
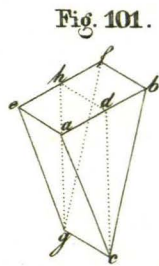
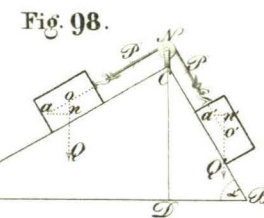
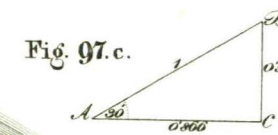
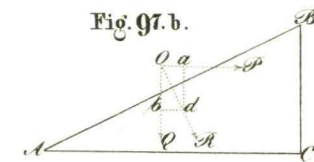
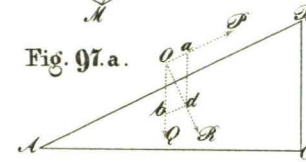
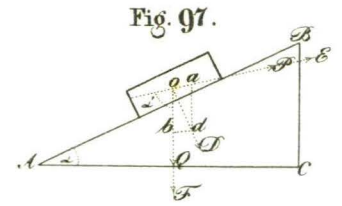
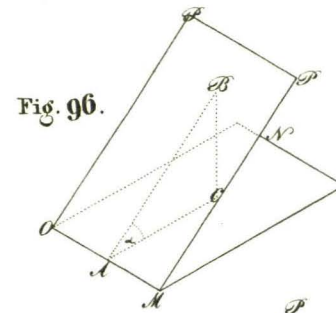
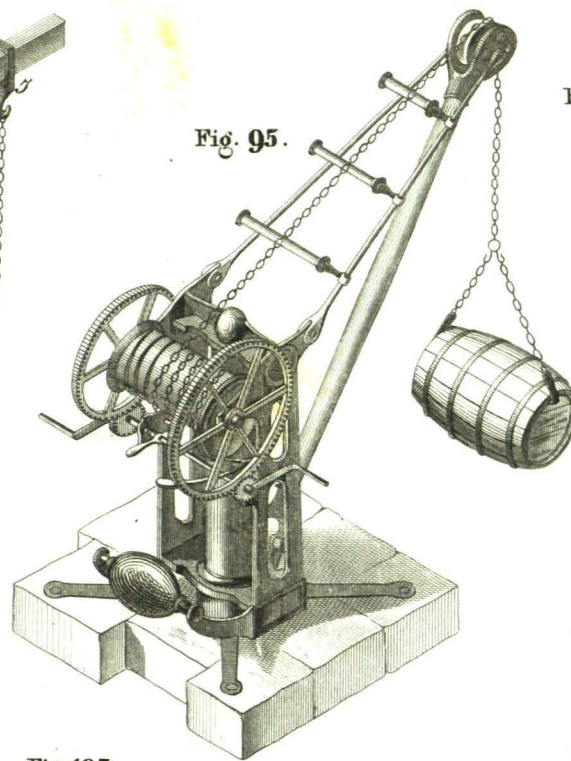
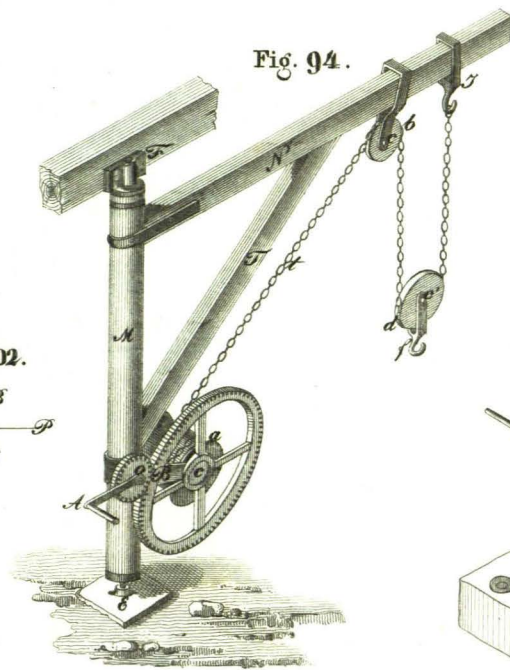
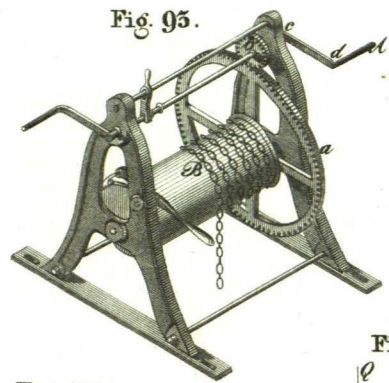

Fig. 80.





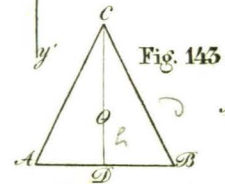
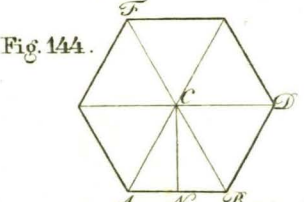
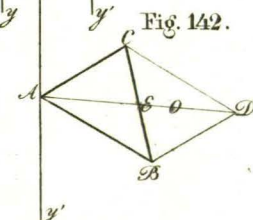
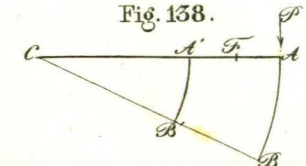
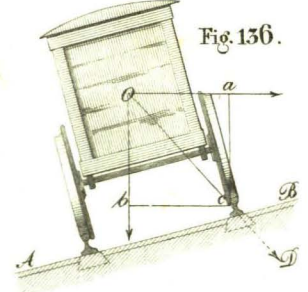
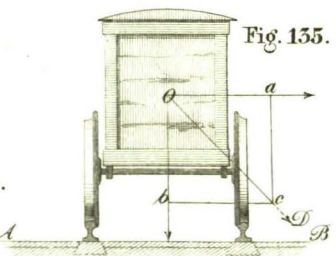
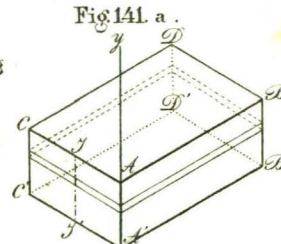
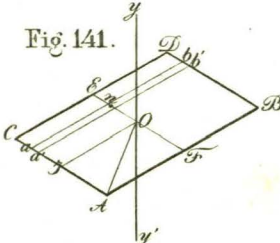
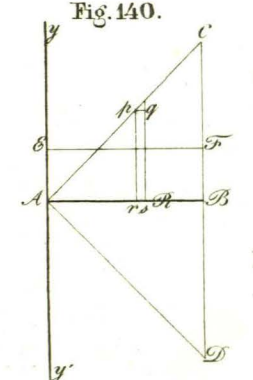
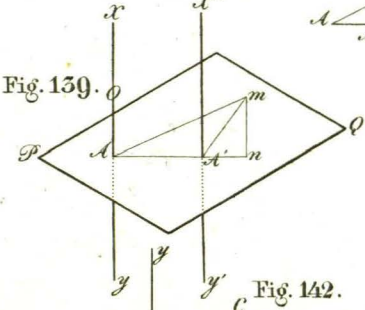
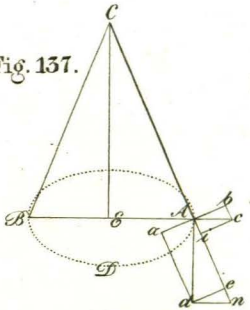
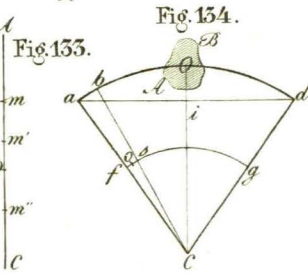
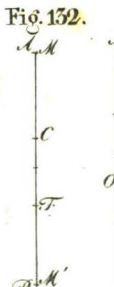
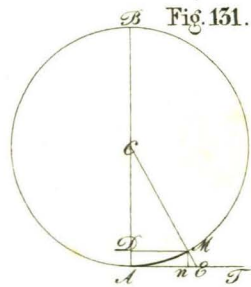
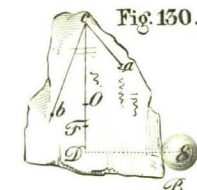
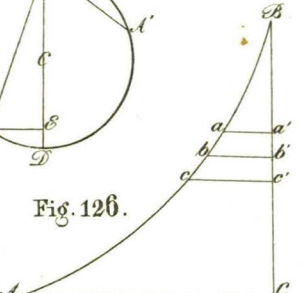
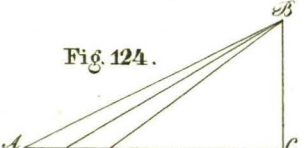
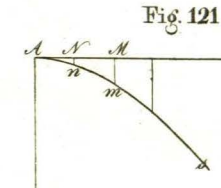
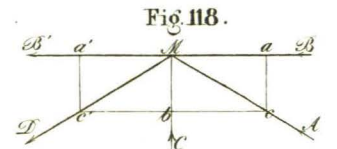
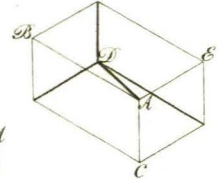
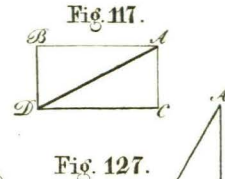
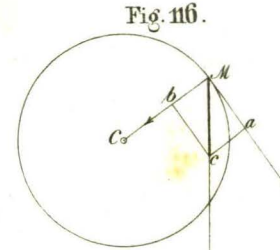
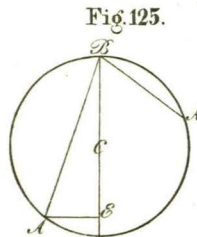
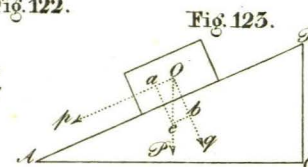
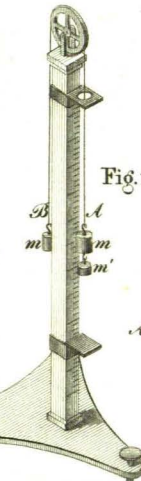
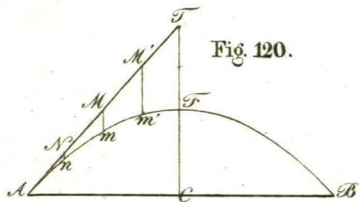
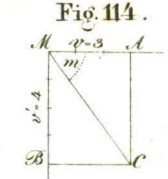
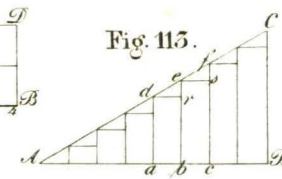
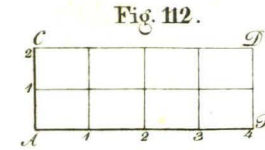
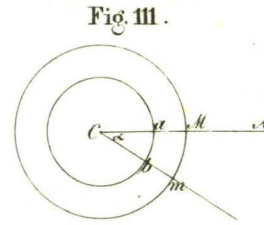
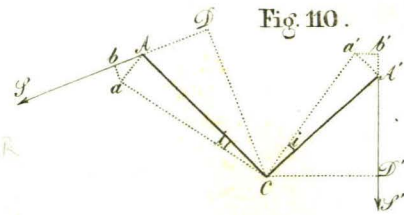
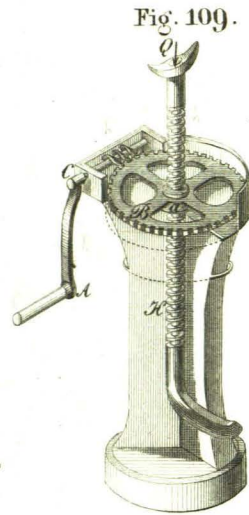
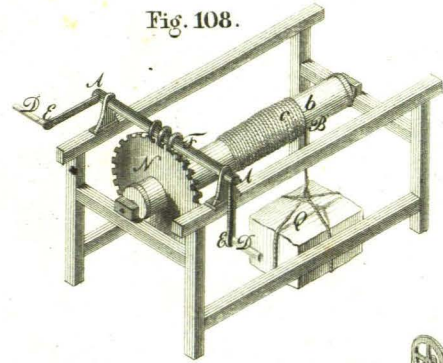

Fig. 145.

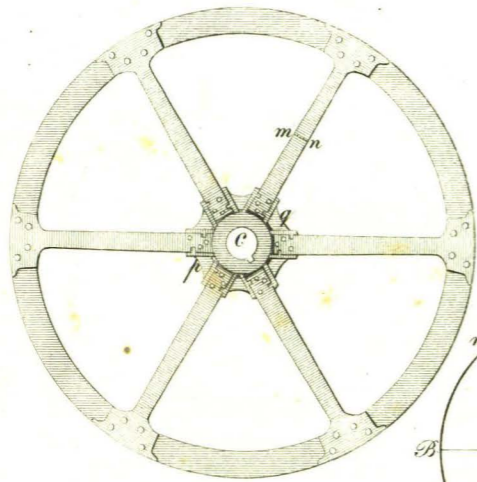

Fig. 146.

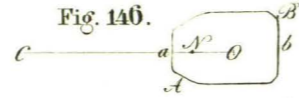

Fig. 146 (a)

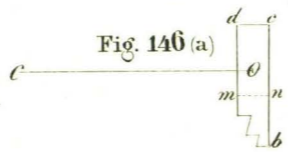

Fig. 147.

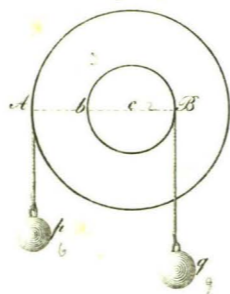

Fig. 148.

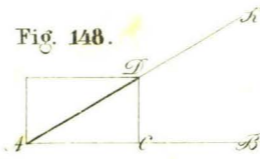

Fig. 149.



Fig. 150.

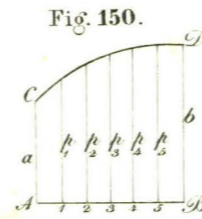

Fig. 160.

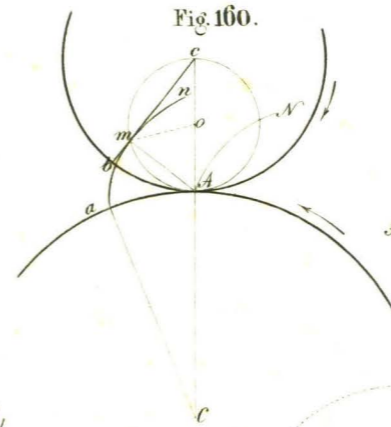

Fig. 151.

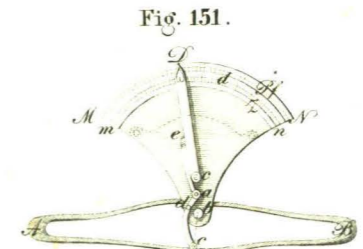

Fig. 153.

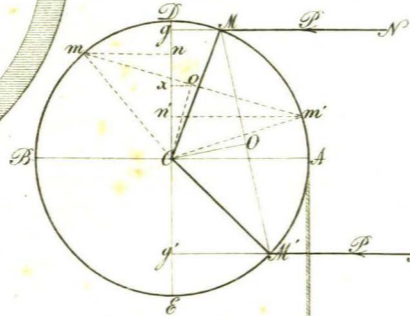

Fig. 158.

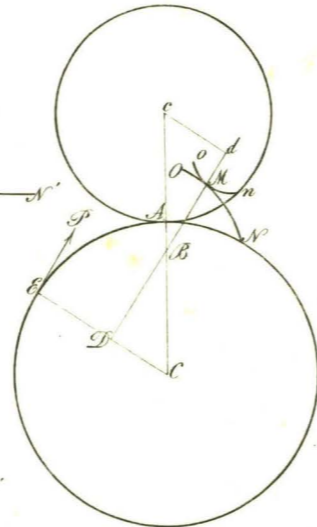

Fig. 161.

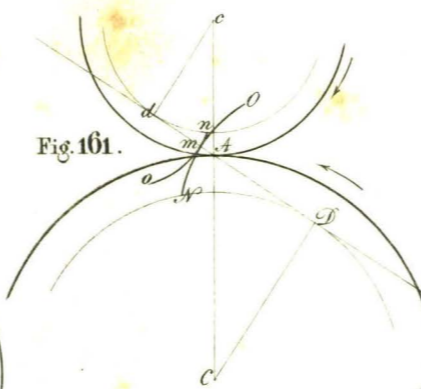

Fig. 163.

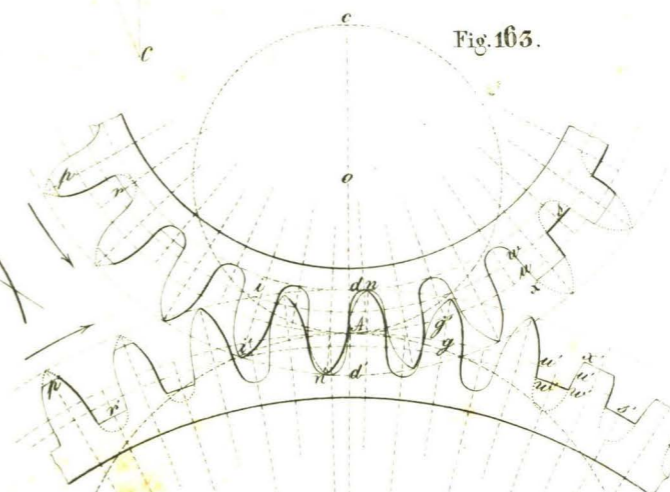

Fig. 152.

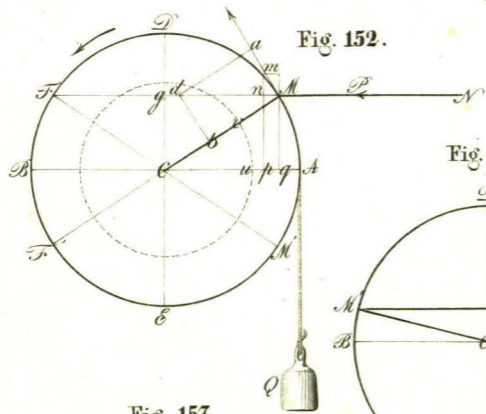

Fig. 154.

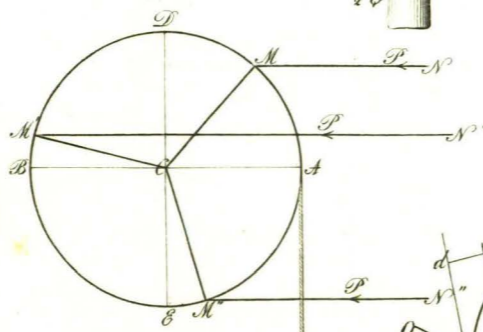

Fig. 157.

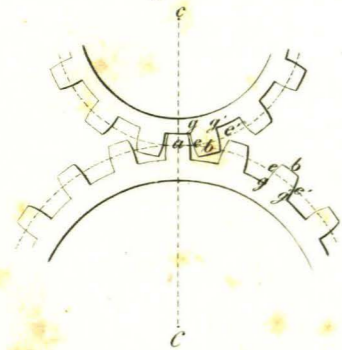

Fig. 156.

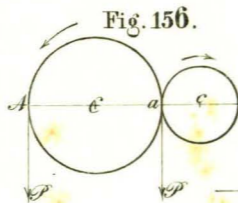

Fig. 159.

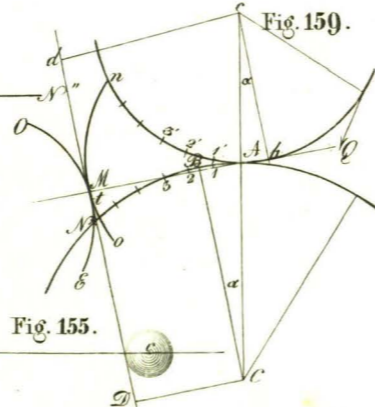
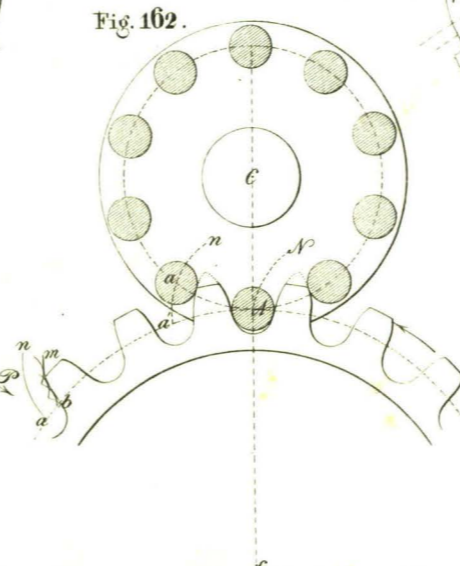
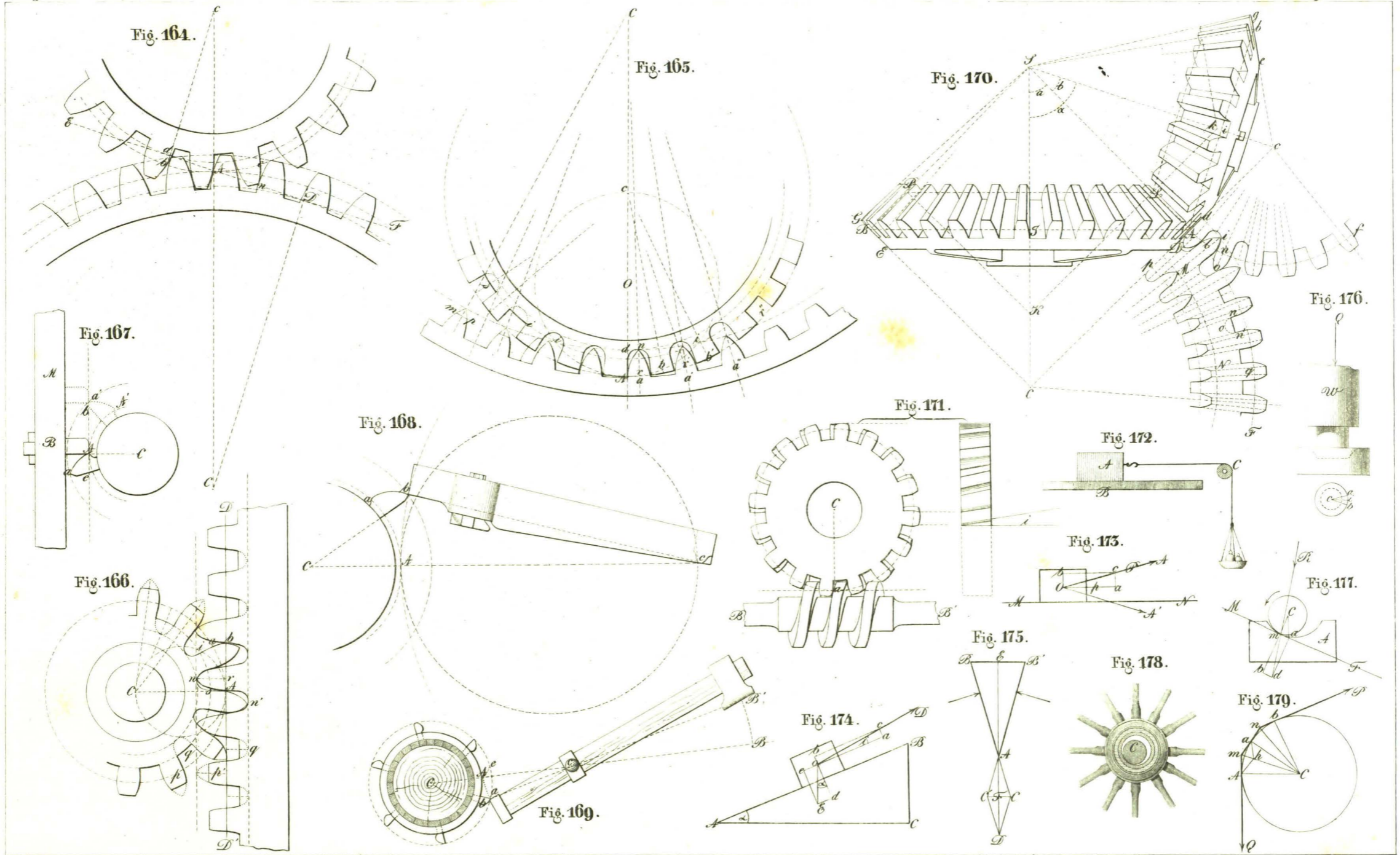

Fig. 155.



Fig. 162.







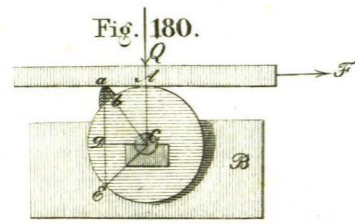

Fig. 185.

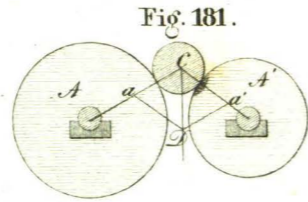
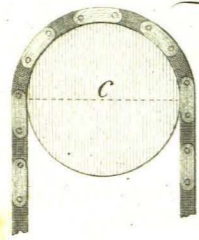

Fig. 186.

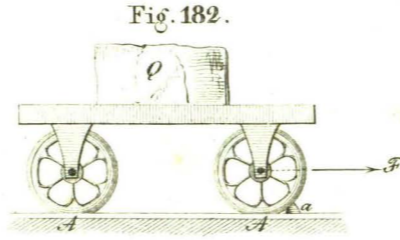
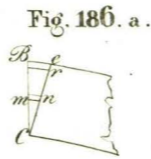
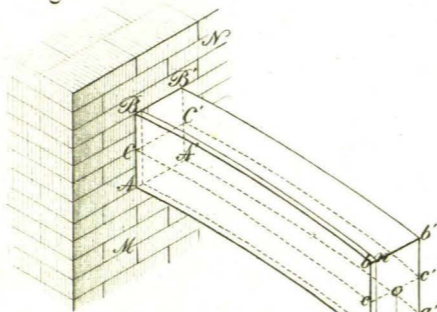

Fig. 187.

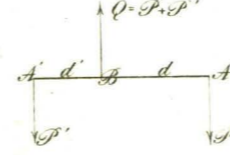

Fig. 187. a.

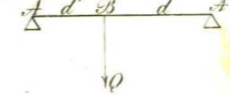

Fig. 192.

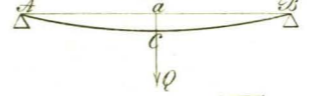

Fig. 198.

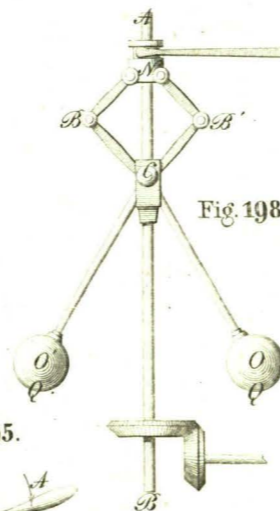

Fig. 183.

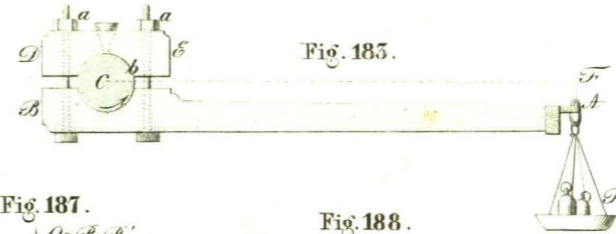

Fig. 188.

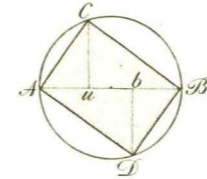

Fig. 189.

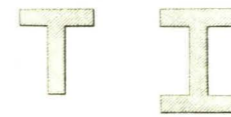

Fig. 196.

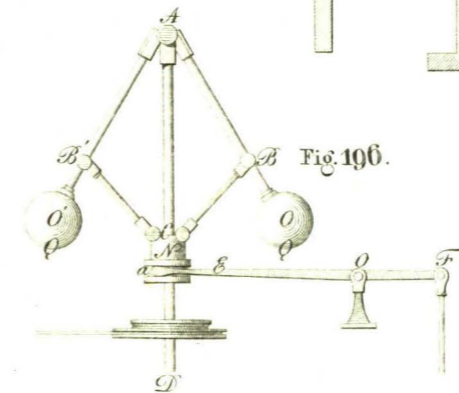

Fig. 184.

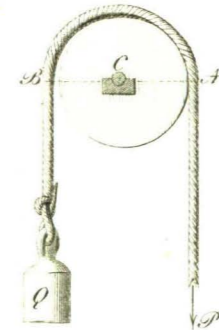

Fig. 200.

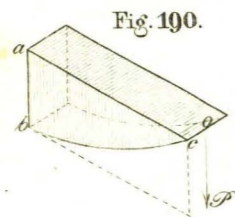

Fig. 190.

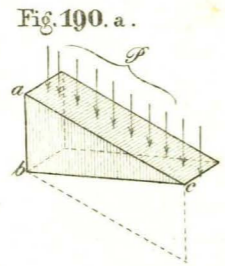

Fig. 190. a.

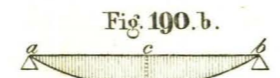

Fig. 190. b.

Fig. 193. a.

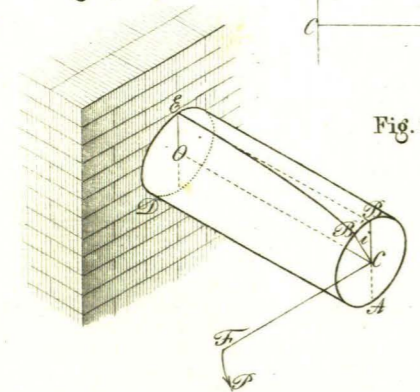

Fig. 191.

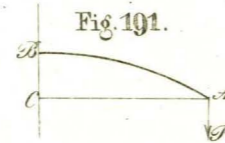

Fig. 193.

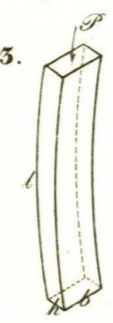

Fig. 194.

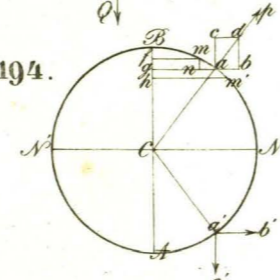

Fig. 195.

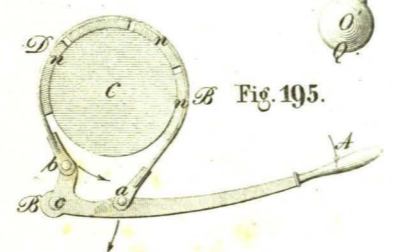

Fig. 197.

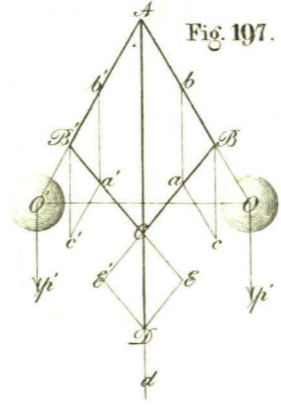
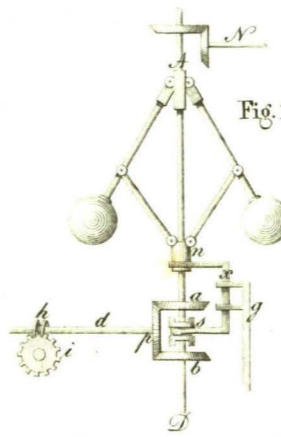

Fig. 199.



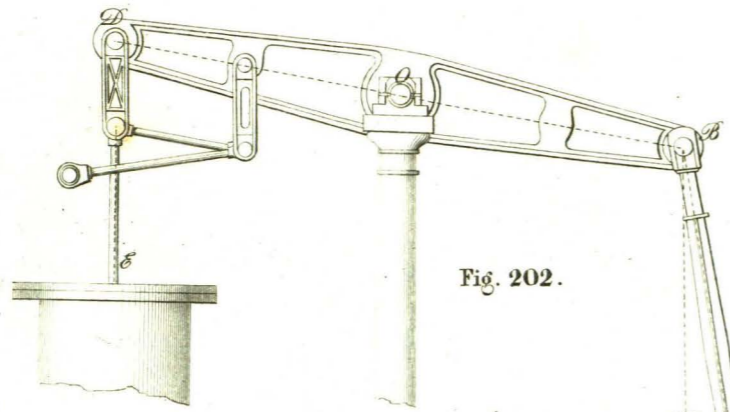

Fig. 202.

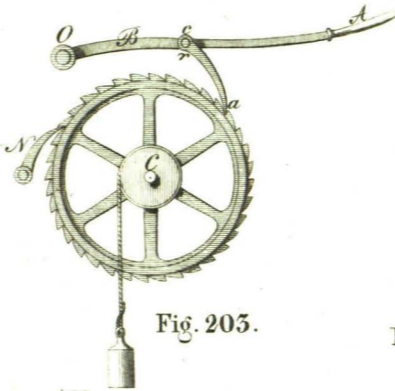

Fig. 203.

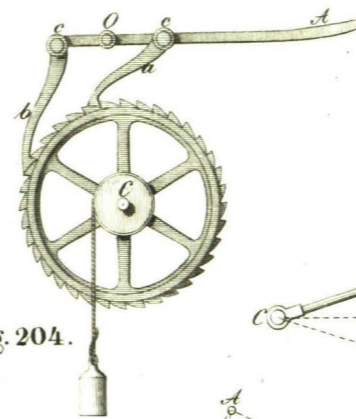

Fig. 204.

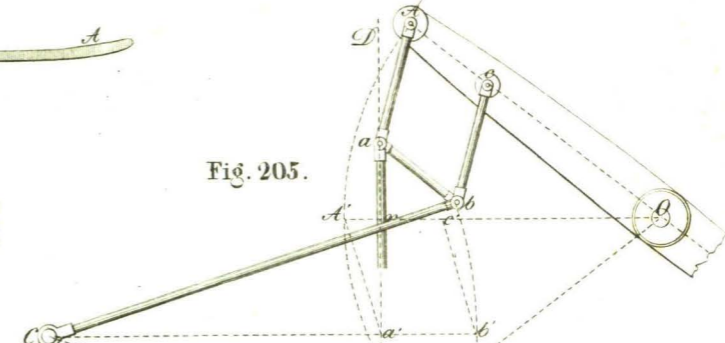

Fig. 205.

Fig. 201.

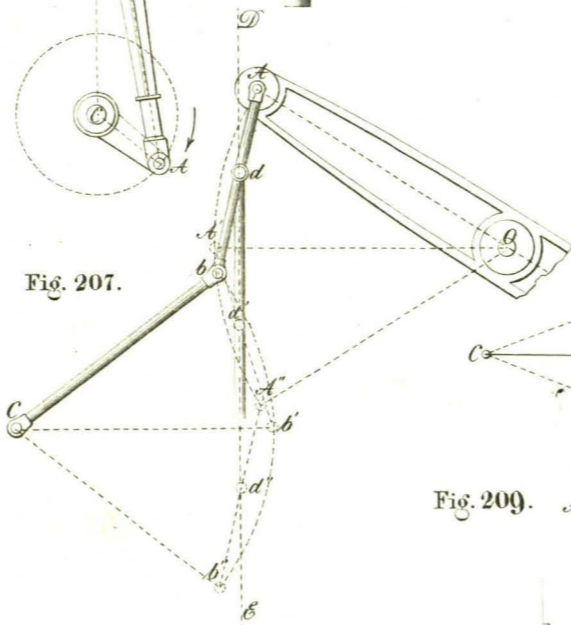
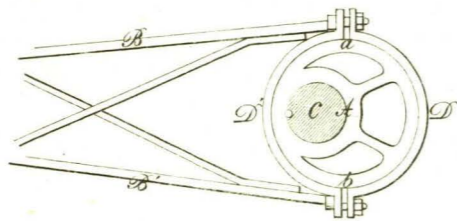

Fig. 207.

Fig. 208. a.

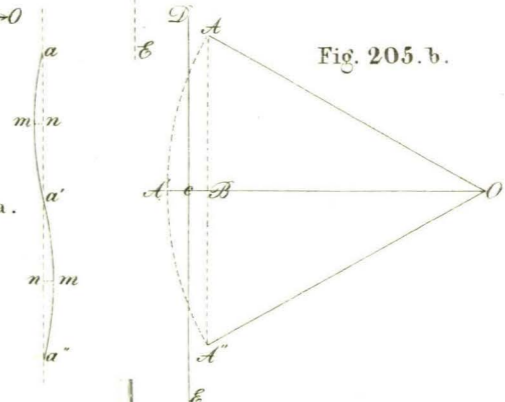
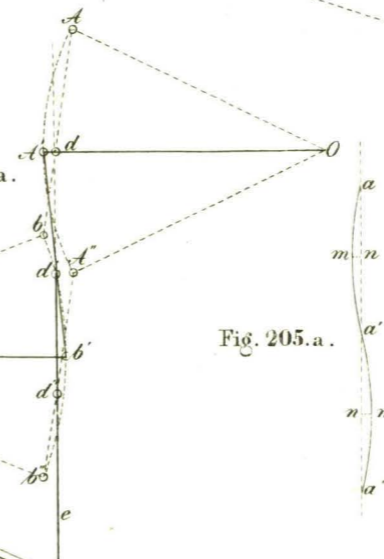

Fig. 205. a.

Fig. 205. b.

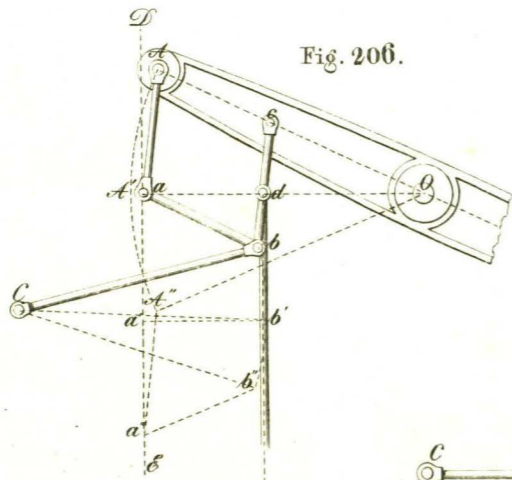

Fig. 206.

Fig. 209.

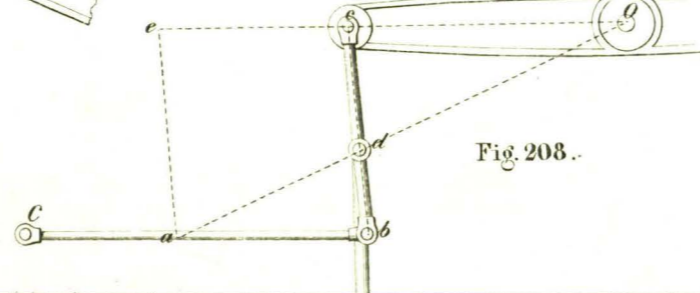
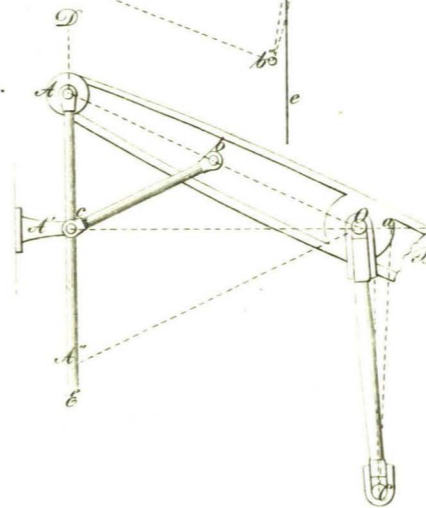

Fig. 208. .

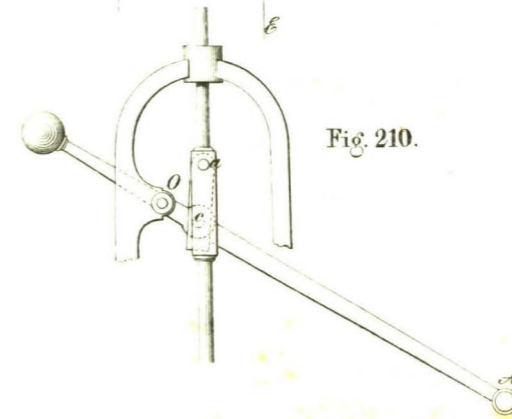

Fig. 210.

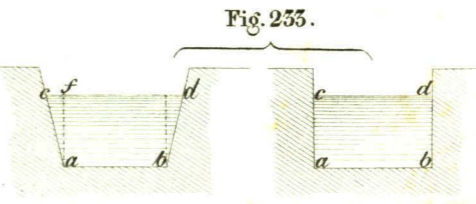
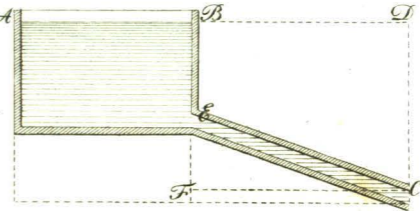
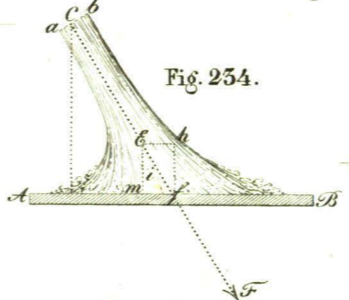
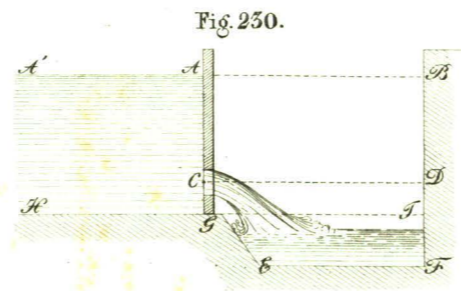
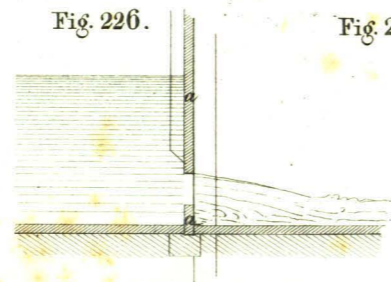
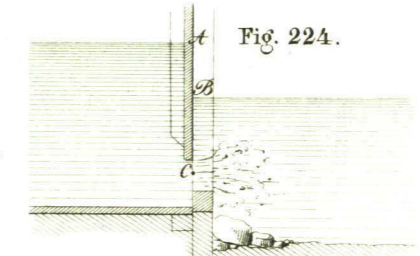
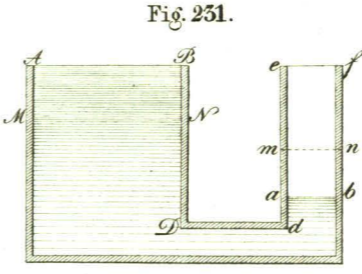
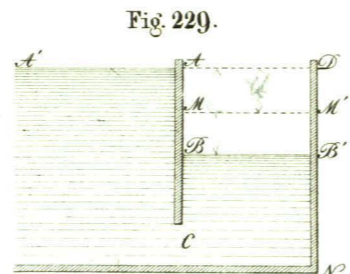
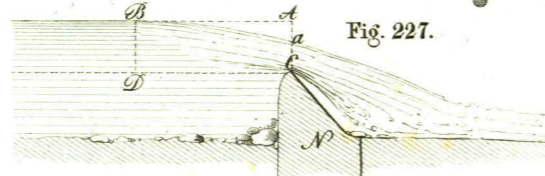
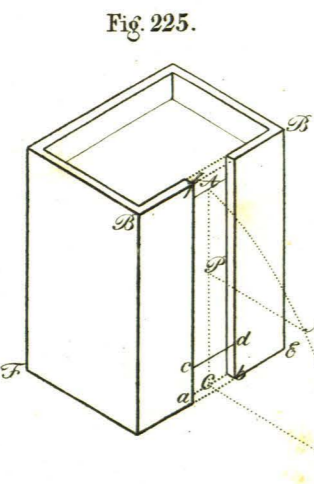
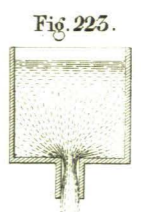
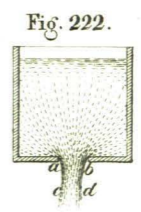
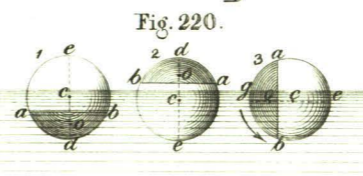
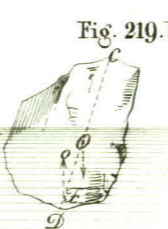
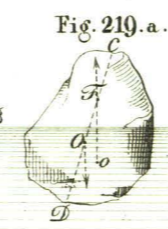
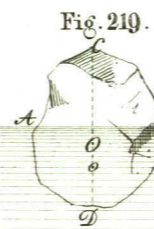
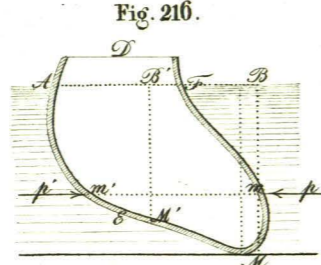
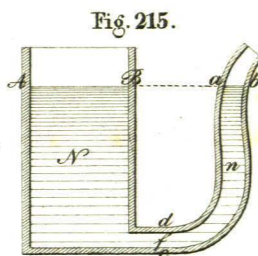
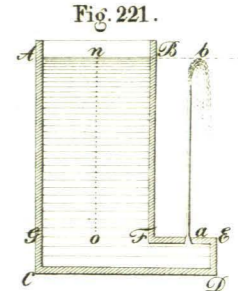
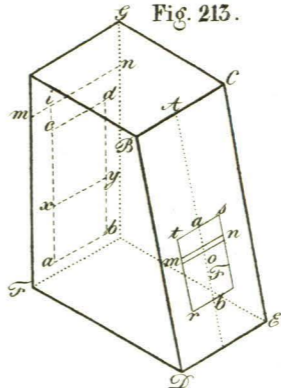
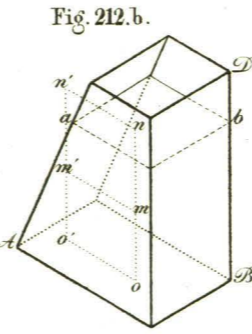
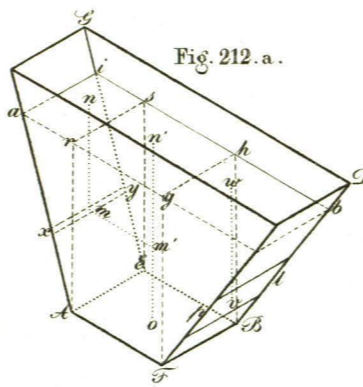
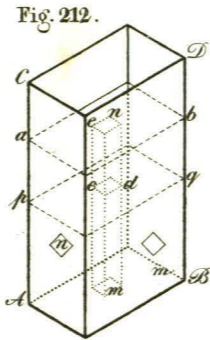
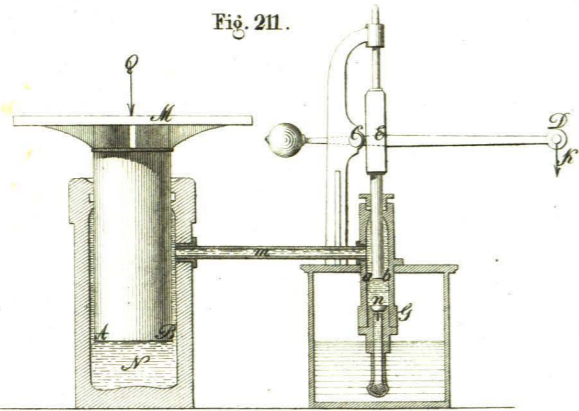

Fig. 235.

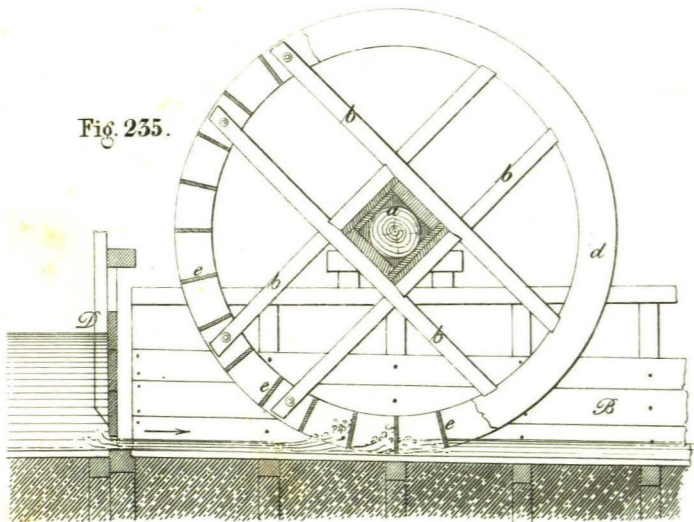

Fig. 235. a.

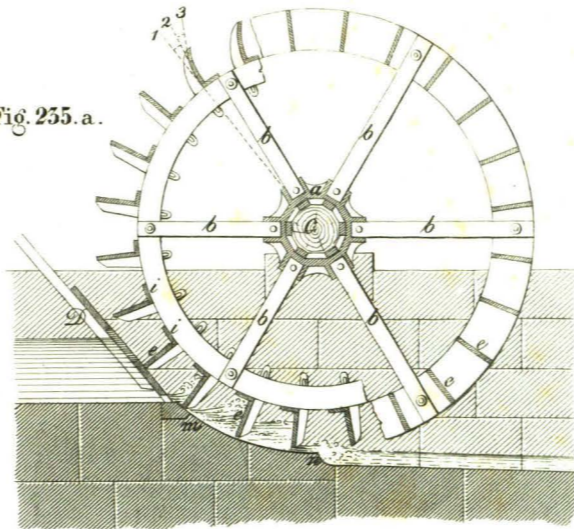

Fig. 237.

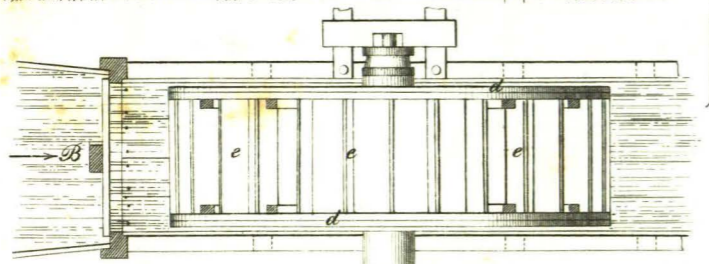
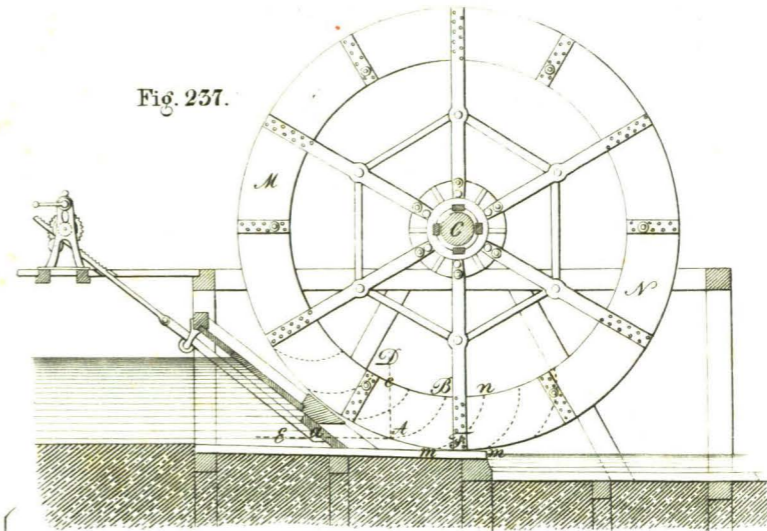

Fig. 235. b.

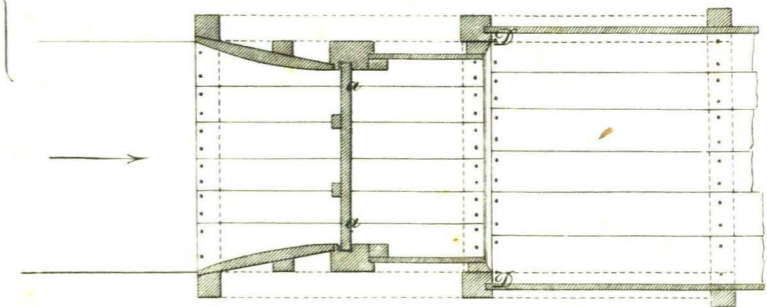
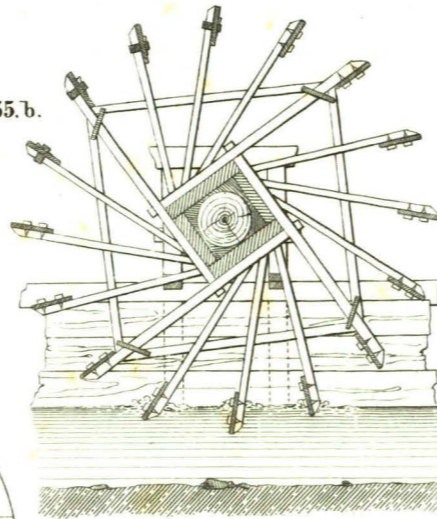

Fig. 238. a.

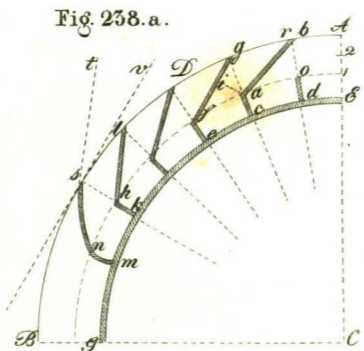

Fig. 238.

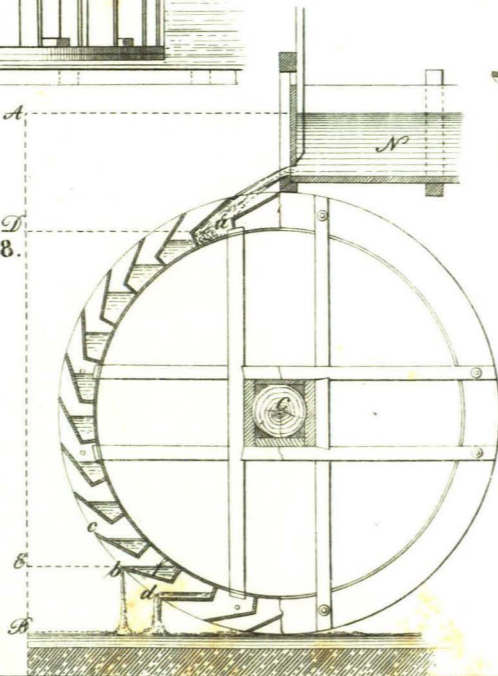

Fig. 236

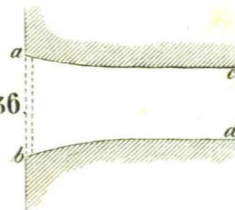

Fig. 236. a.

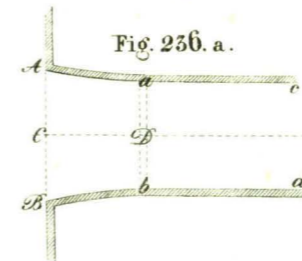

Fig. 239.

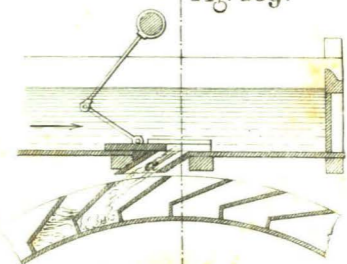

Fig. 240.

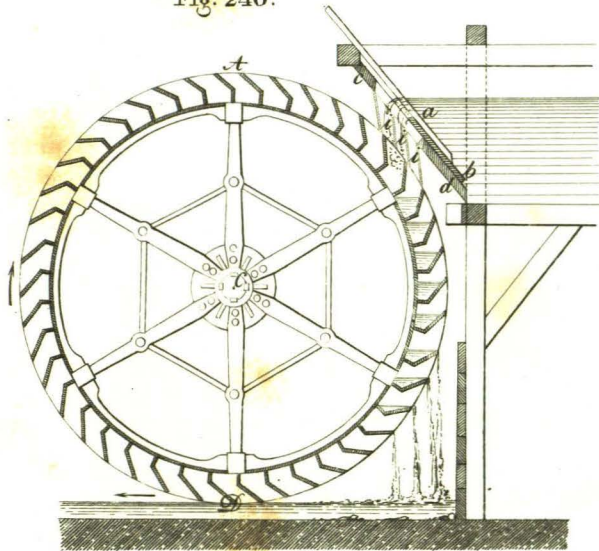

Fig. 241.

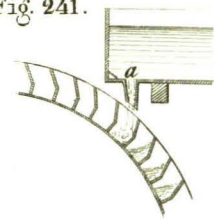

Fig. 242.

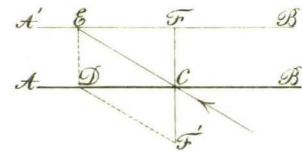

Fig. 243.

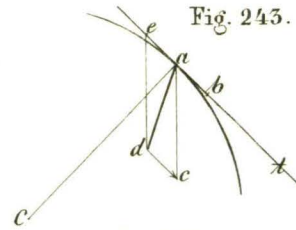

Fig. 249.

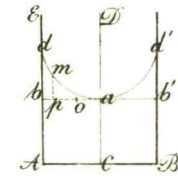

Fig. 251.

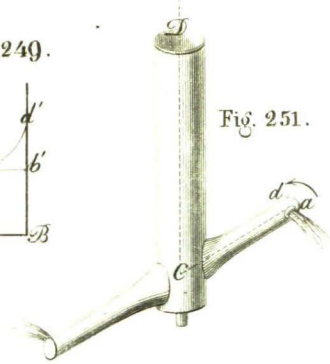

Fig. 245.

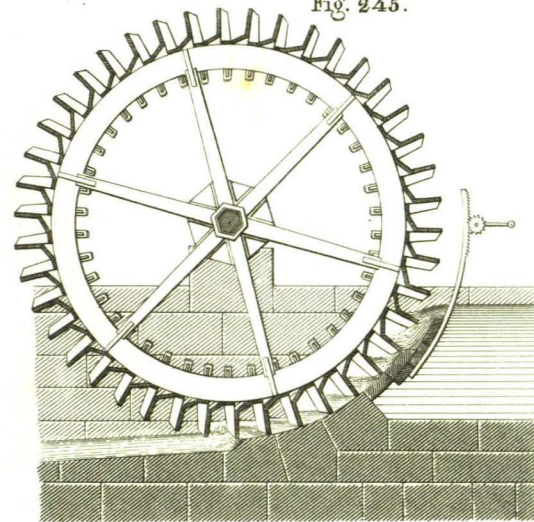

Fig. 248.

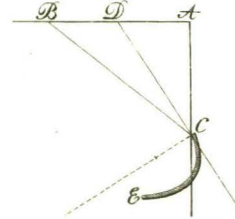

Fig. 250.

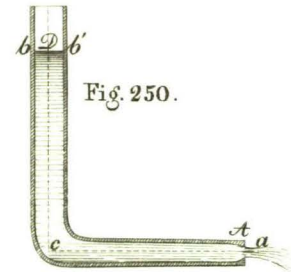

Fig. 252.

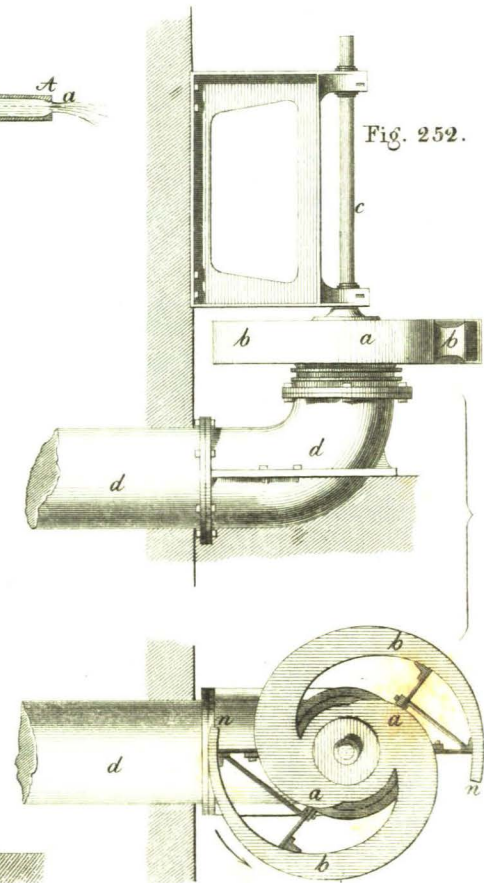

Fig. 244.

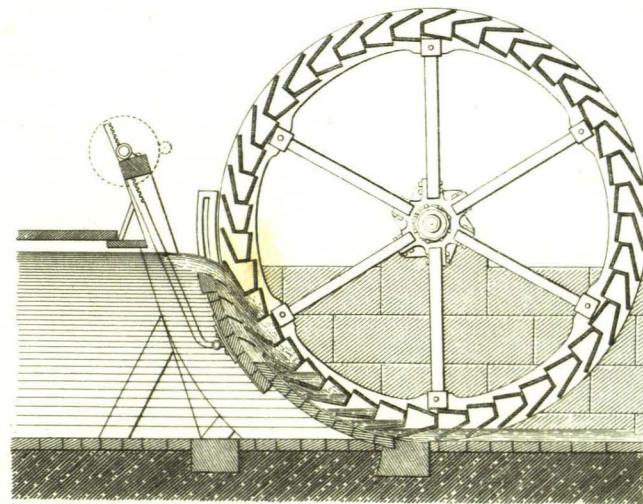

Fig. 246.

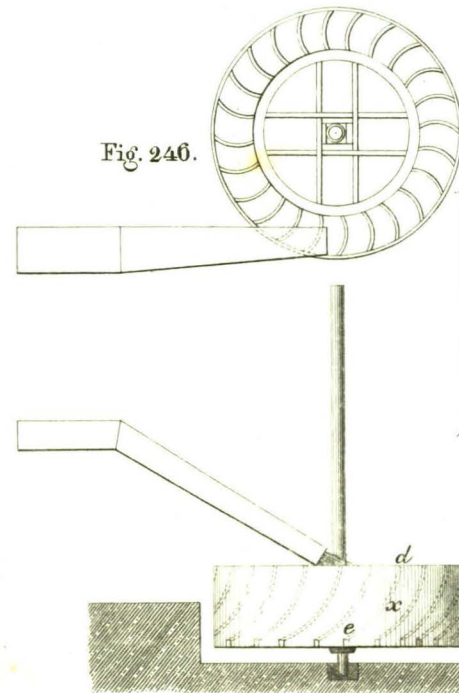

Fig. 247.

