

Fig.1 Elevation

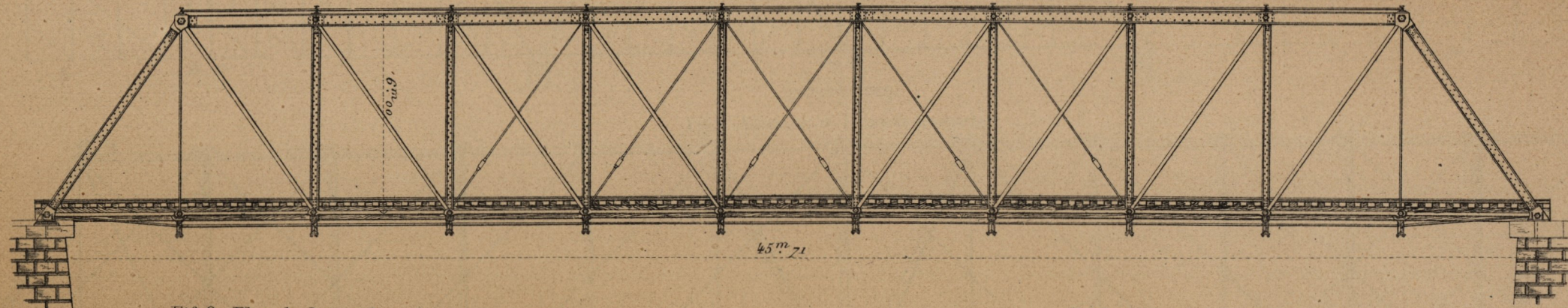

Fig.2 Plan de la corde inférieure

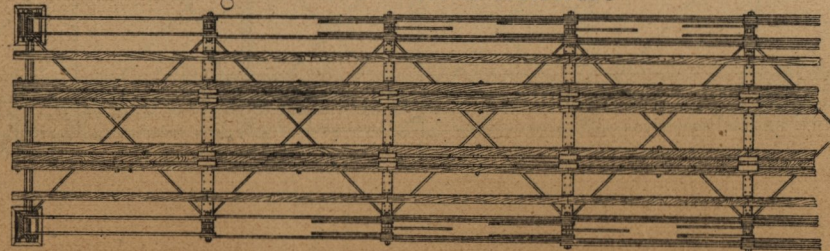

Fig.3 Plan de la corde supérieure

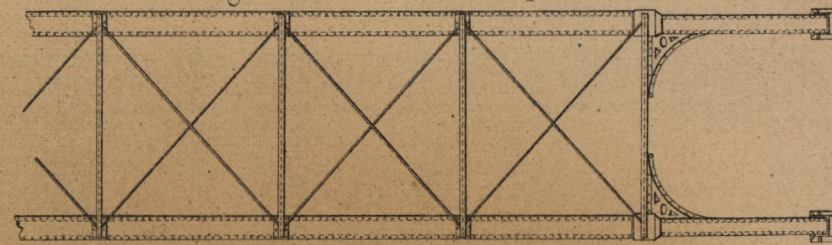

Fig.4

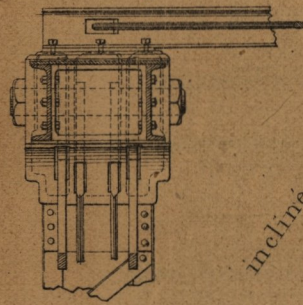

Fig.5

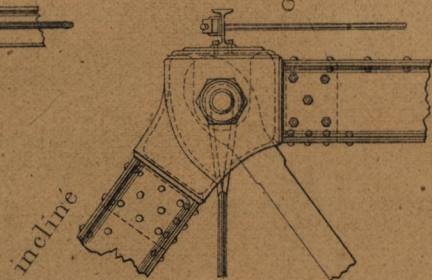
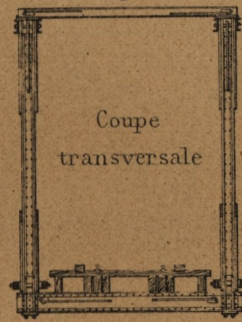

Fig.6



Assemblage d'un montant avec la corde supérieure

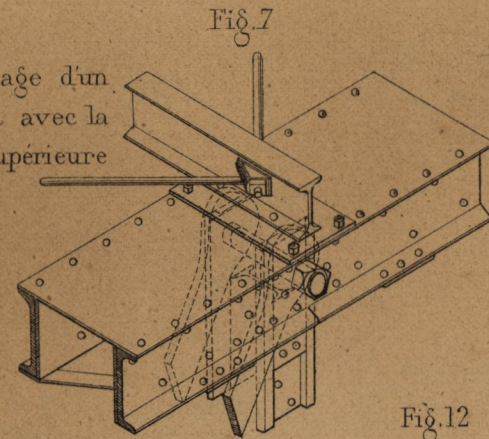

Fig.8

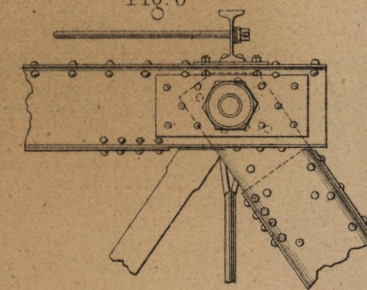

Fig.9

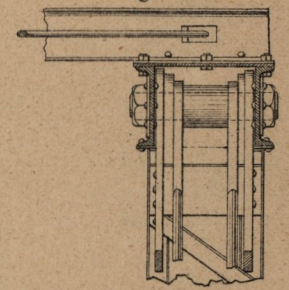

Fig.12

Assemblage d'un montant avec la corde inférieure

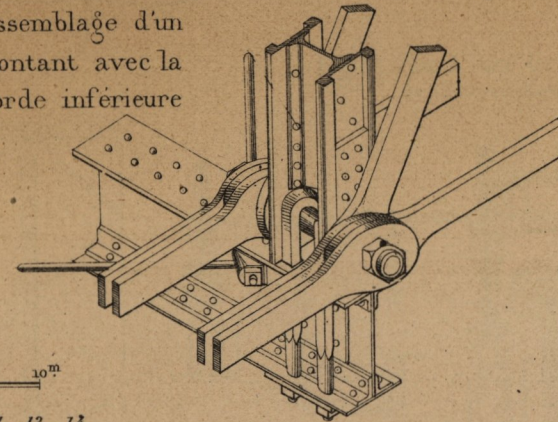

Fig.10

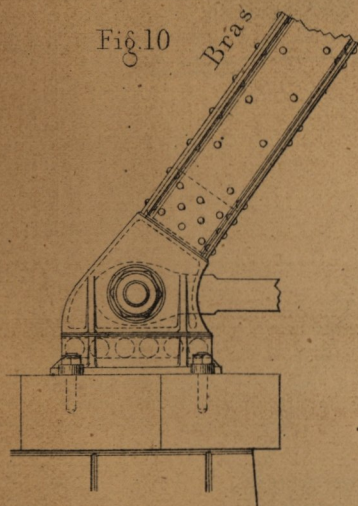

Fig.11

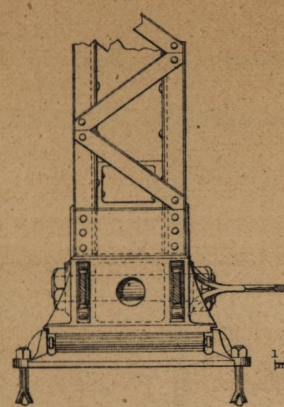

Fig.13

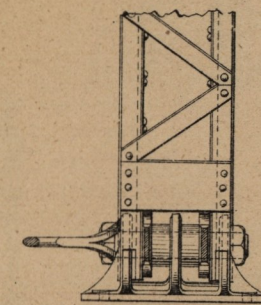
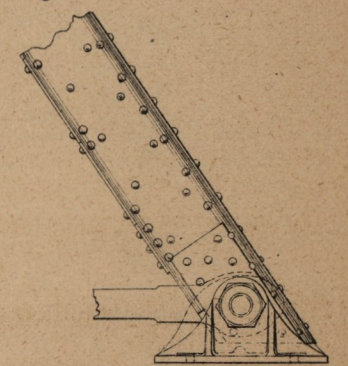
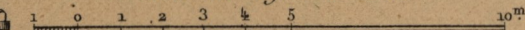

Fig.14



Echelles

Pour les Fig. 1. 2. 3. 6.



Pour les Fig. 4. 5. 8. 9. 10. 11. 13. 14.

