

MODELE DE PONT ROUTIER

Fig 7. Elévation

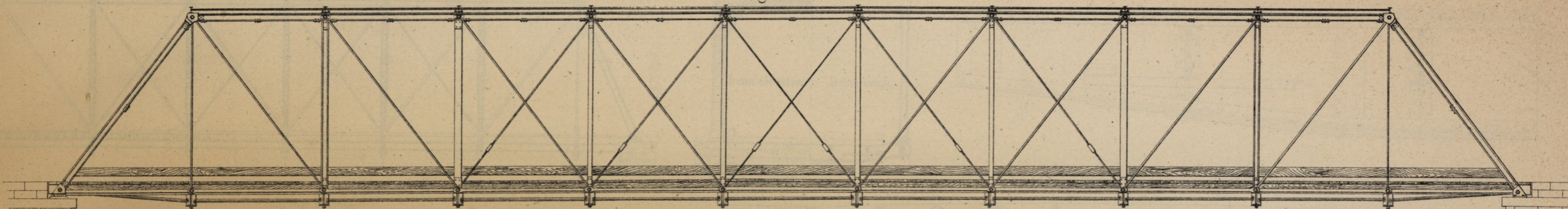

Fig. 8

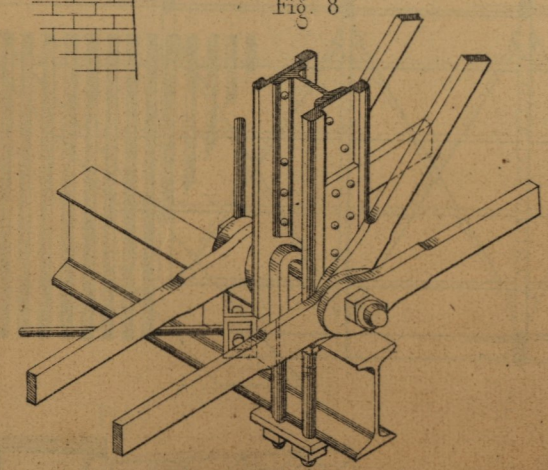

Fig. 9

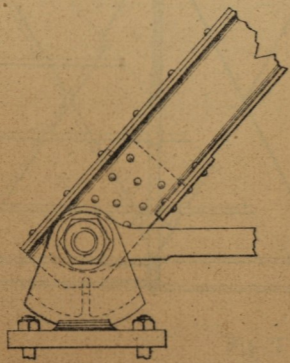

Fig. 10

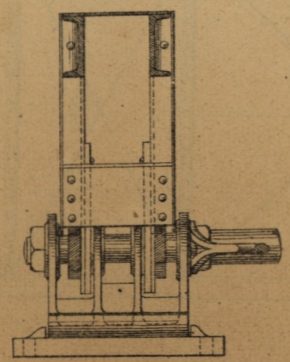

Fig. 11

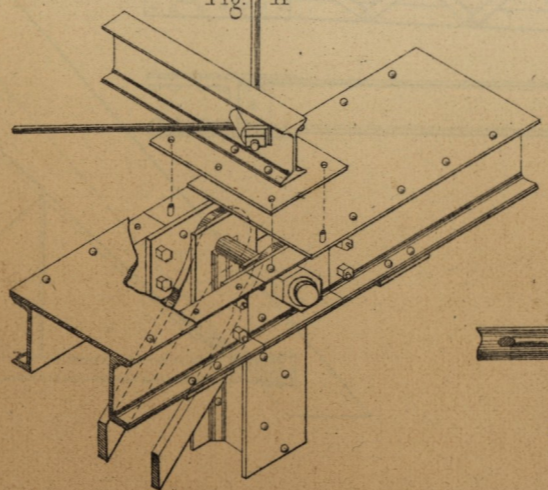

Fig. 12

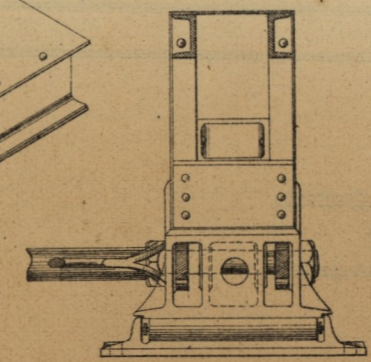

Fig. 13

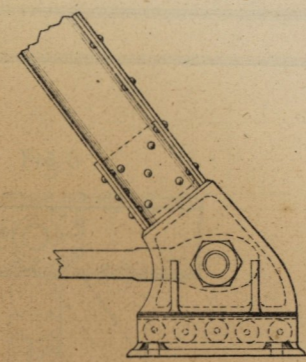

Fig. 14

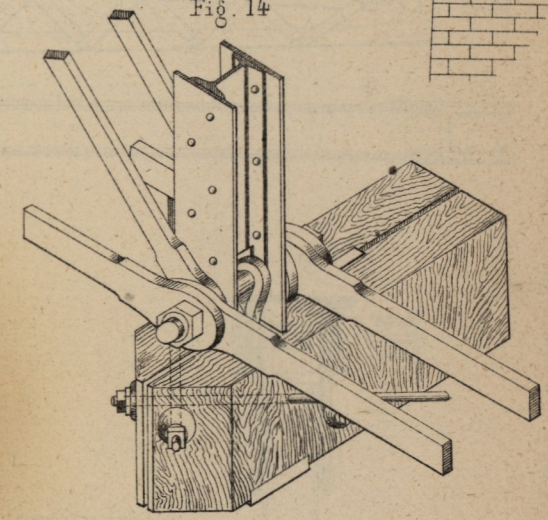

Fig. 4

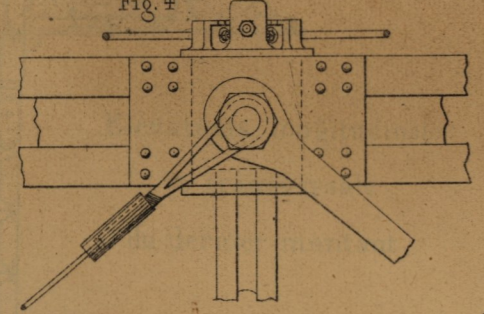
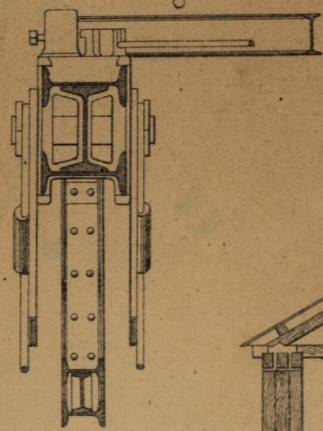

Fig. 3



(PONT SUR L'HUDSON, Chemin de fer de Puer)

Fig. 1. Coupe transversale

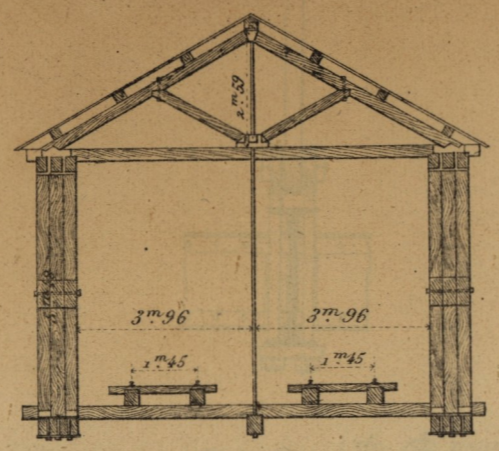

Fig. 2. Coupe Longitudinale

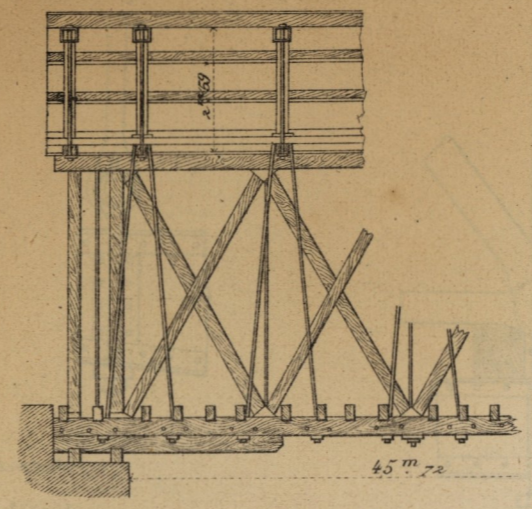

Fig. 7

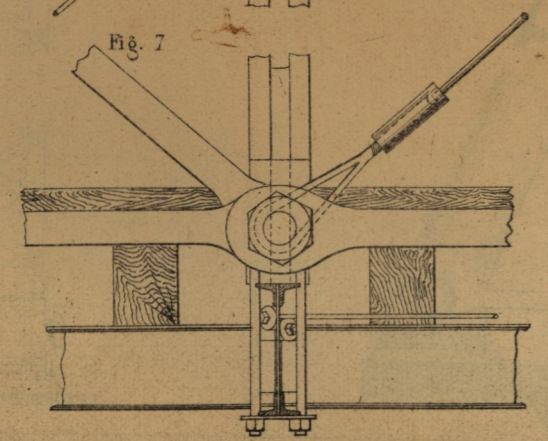

Fig. 6

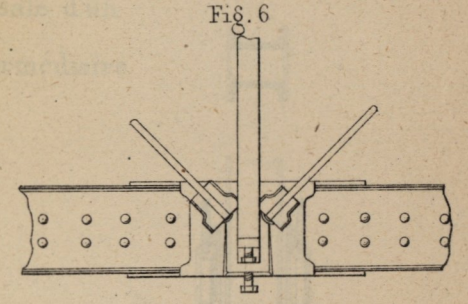

Fig. 5

